

# CREVASSE TABLE RANGE

CV-TB.180x100

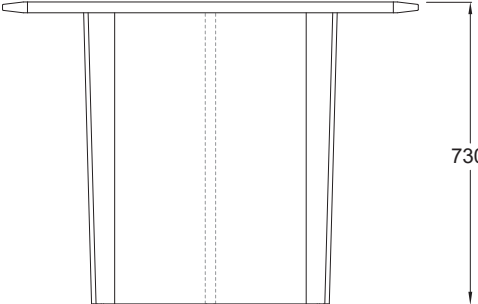
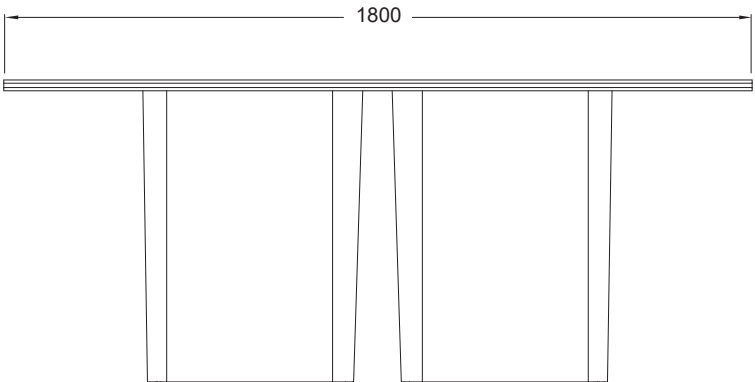
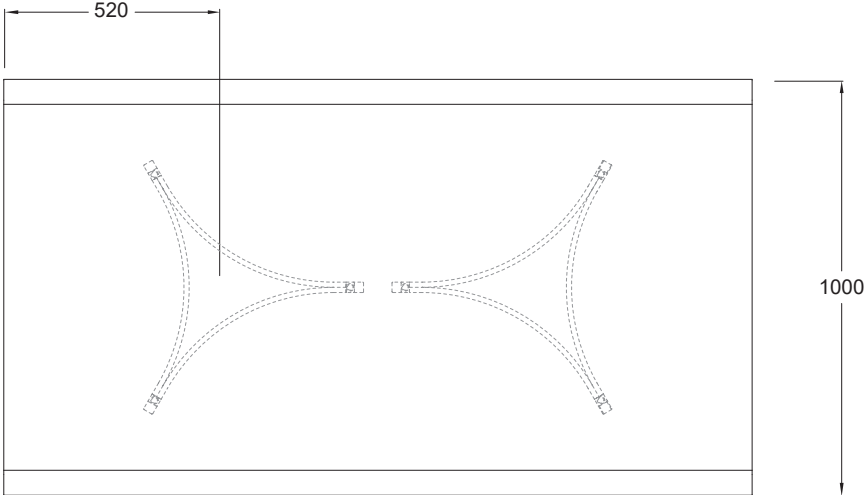

# CREVASSE TABLE RANGE

CV-TB.210x100

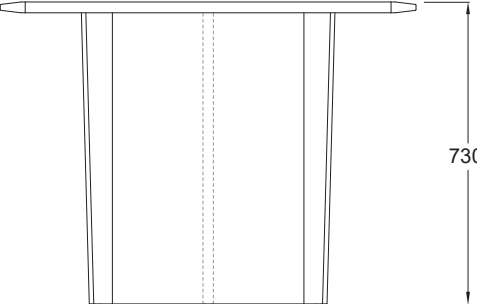
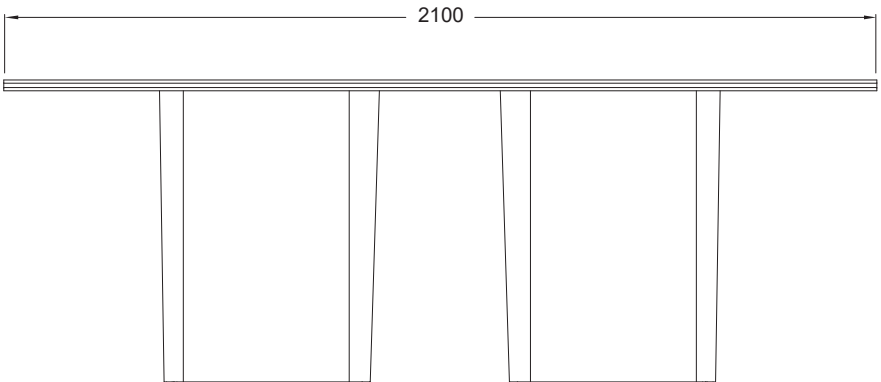
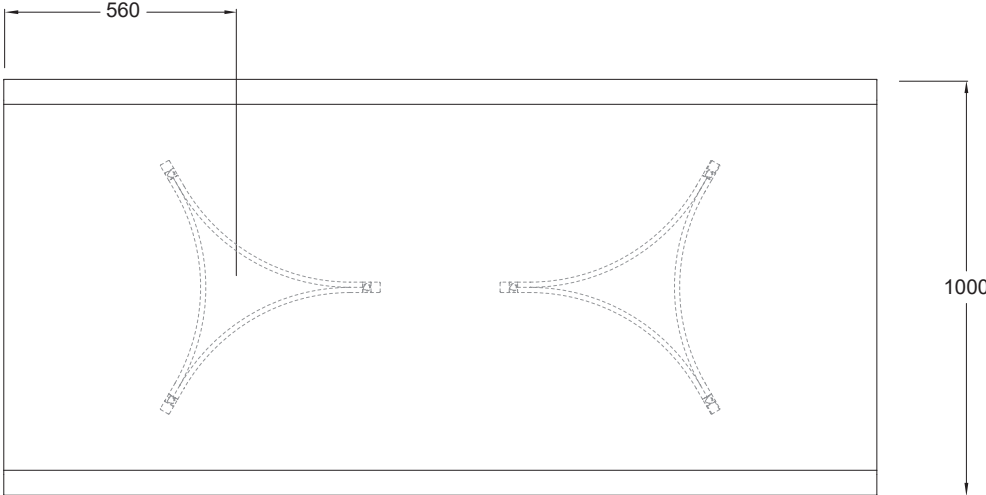

# CREVASSE TABLE RANGE

CV-TB.240x100

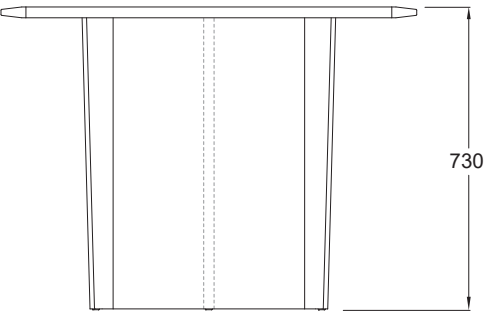
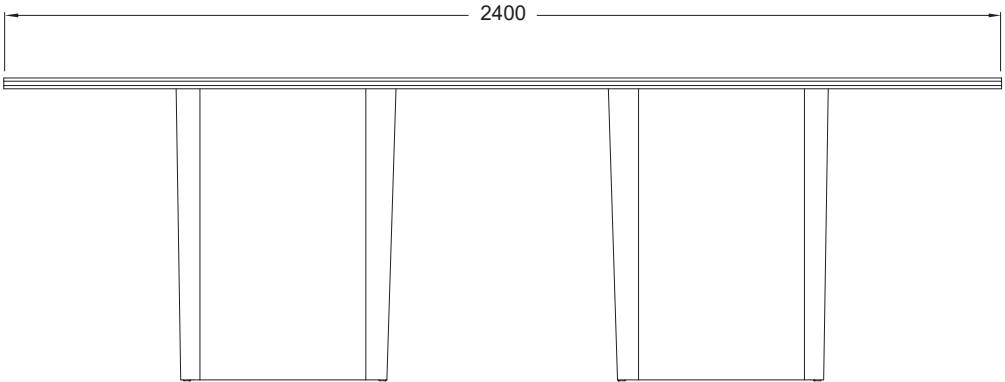
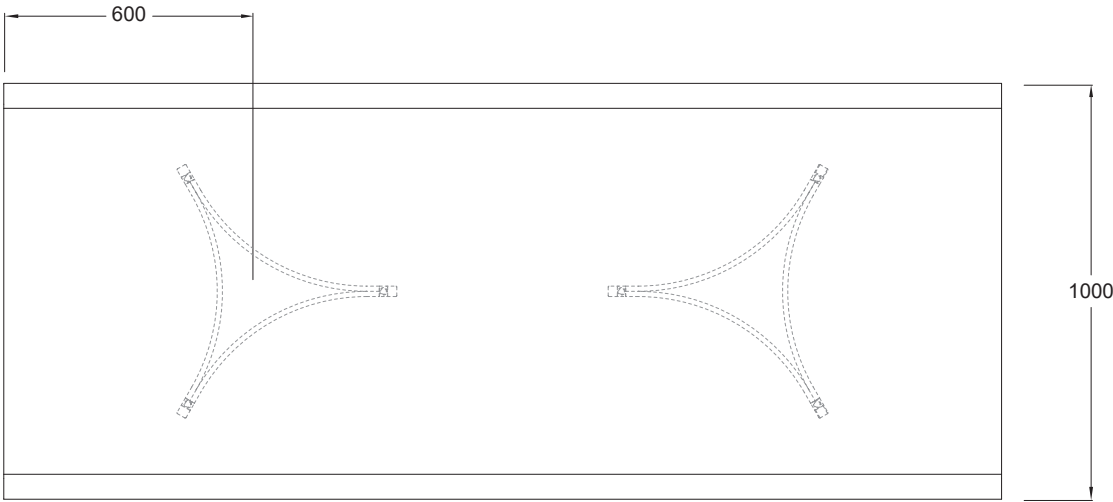

# CREVASSE TABLE RANGE

CV-TB.270x100

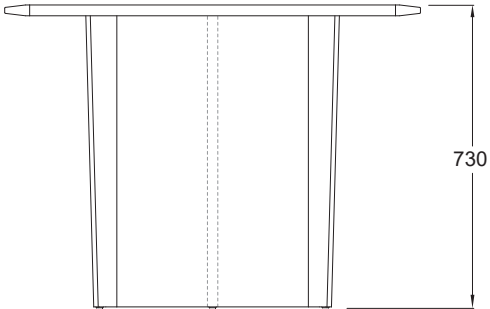
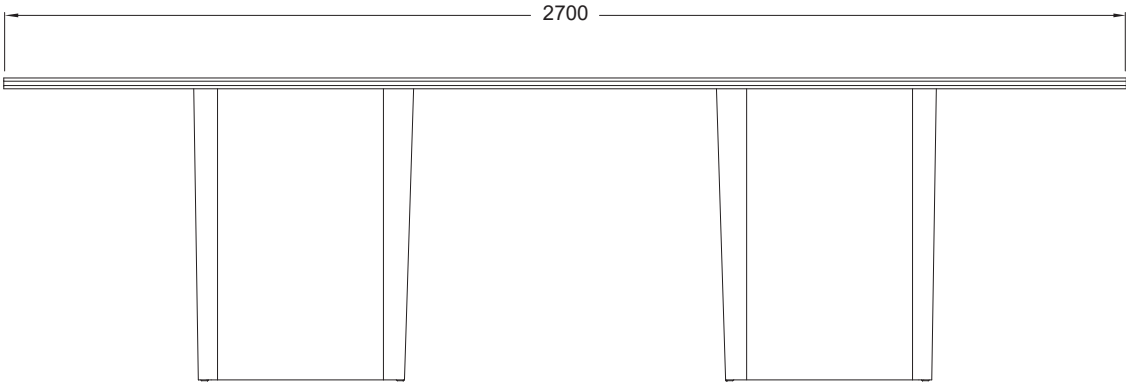
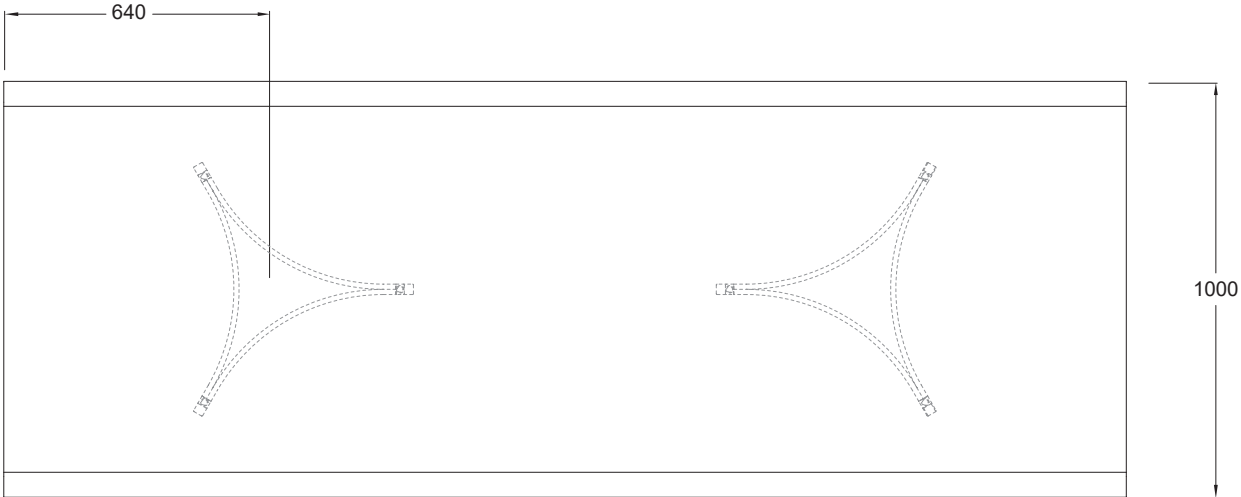
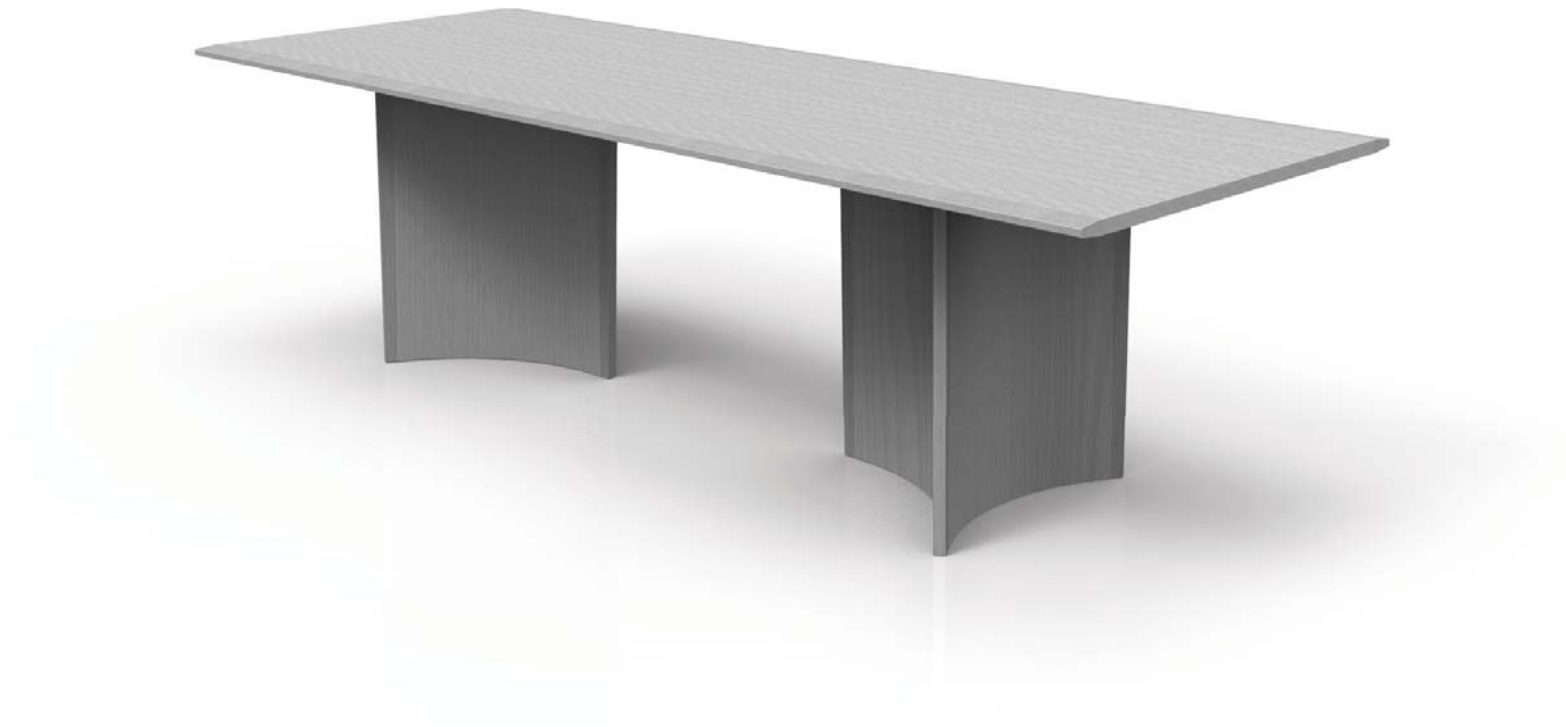

# CREVASSE TABLE RANGE

CV-TB.300x100

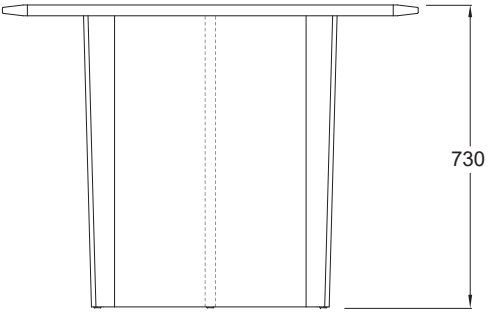
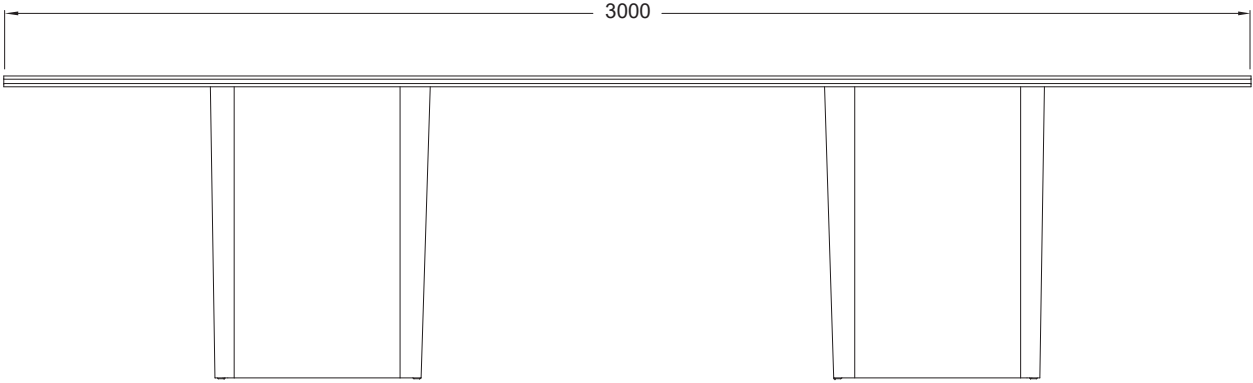
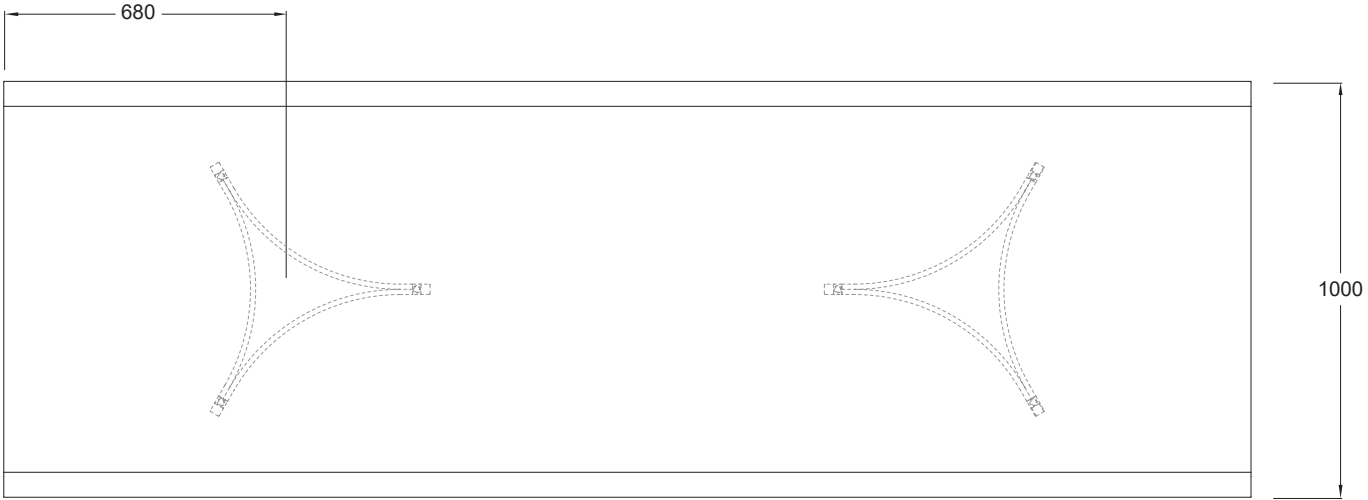

# CREVASSE TABLE RANGE

CV-TB.330x100

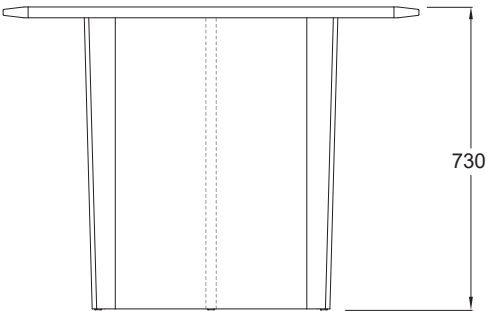
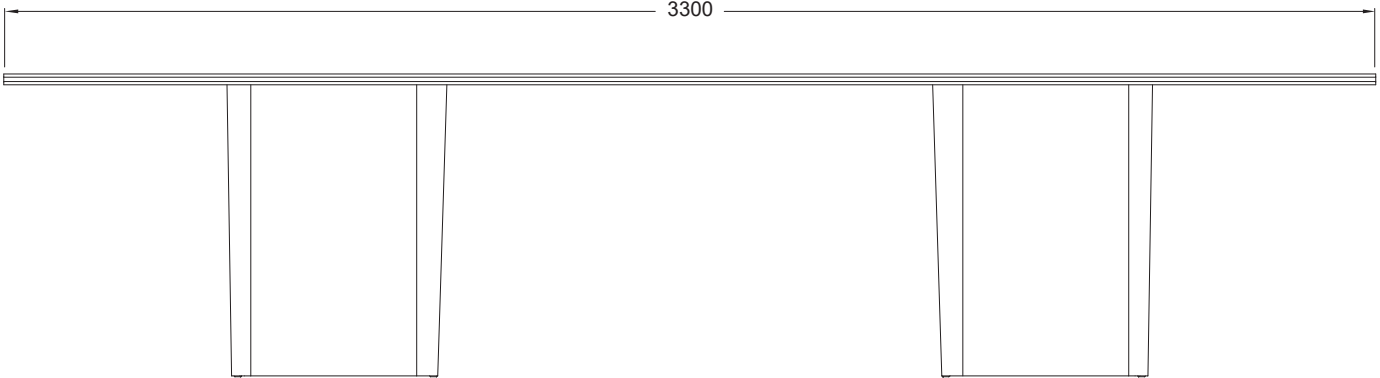

# CREVASSE TABLE RANGE

CV-TB.360x100

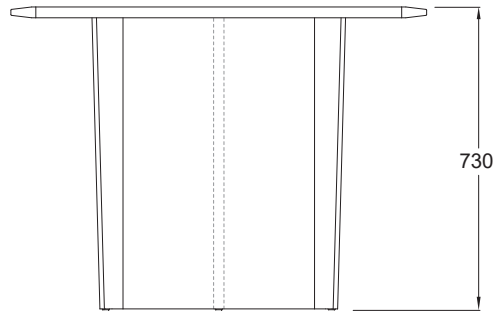
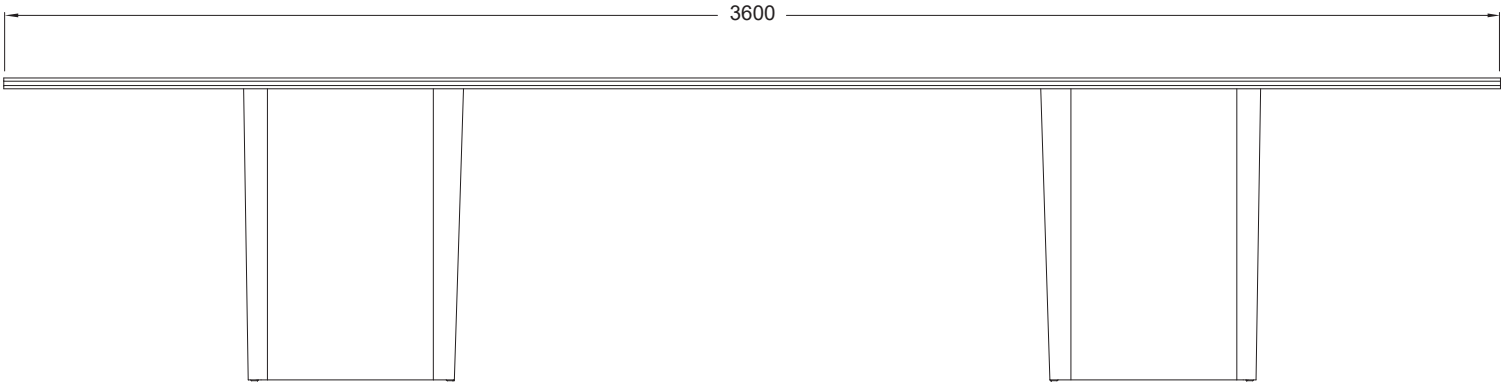
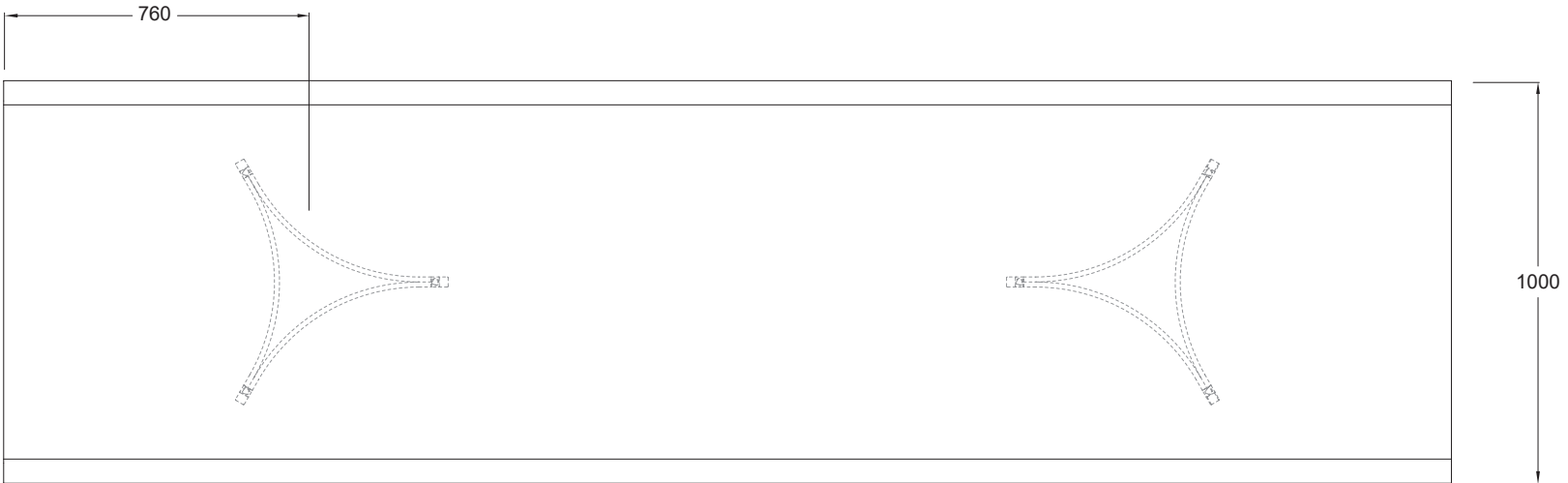

# CREVASSE TABLE RANGE

CV-TB.180x130

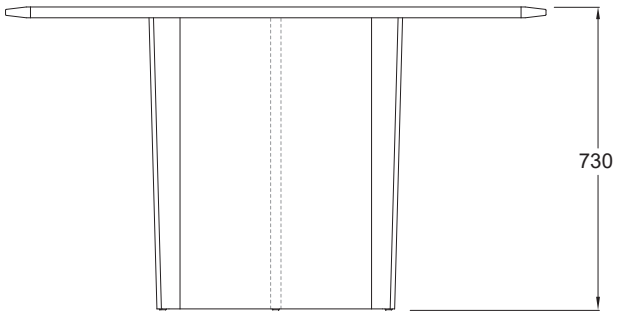
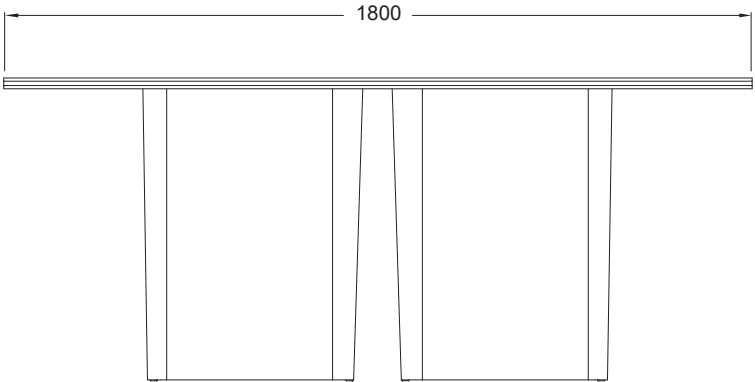
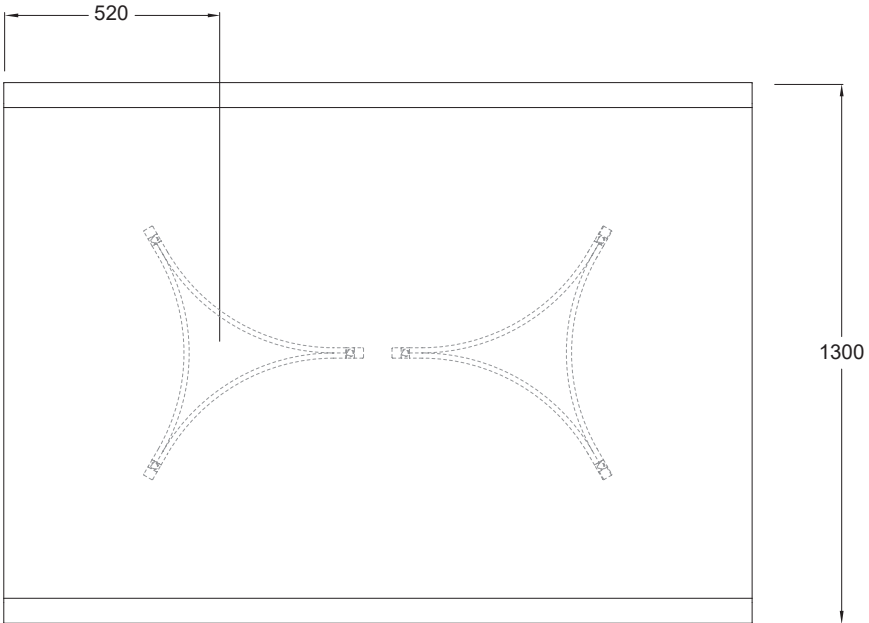
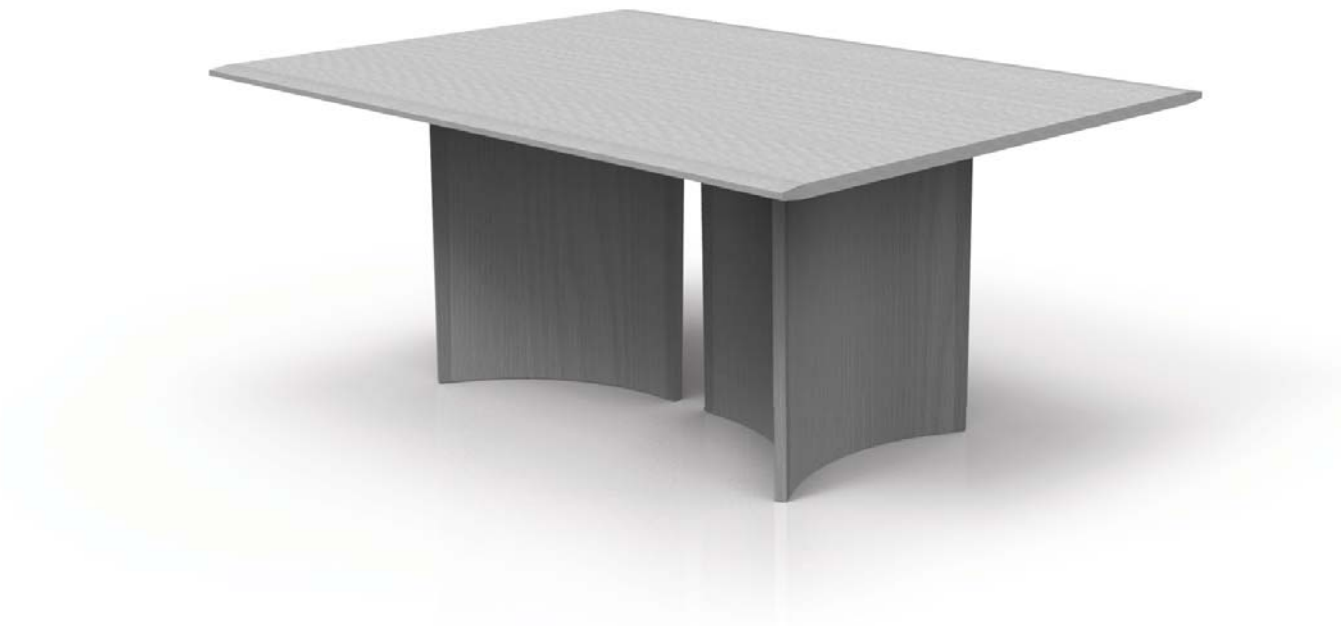



# CREVASSE TABLE RANGE

CV-TB.210x130

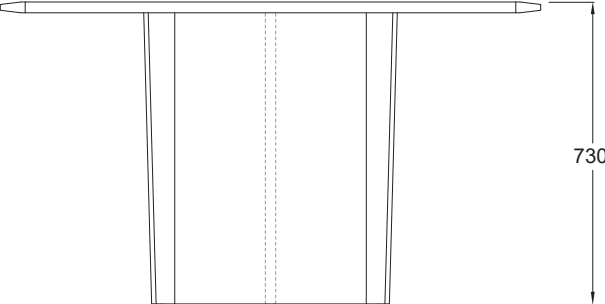
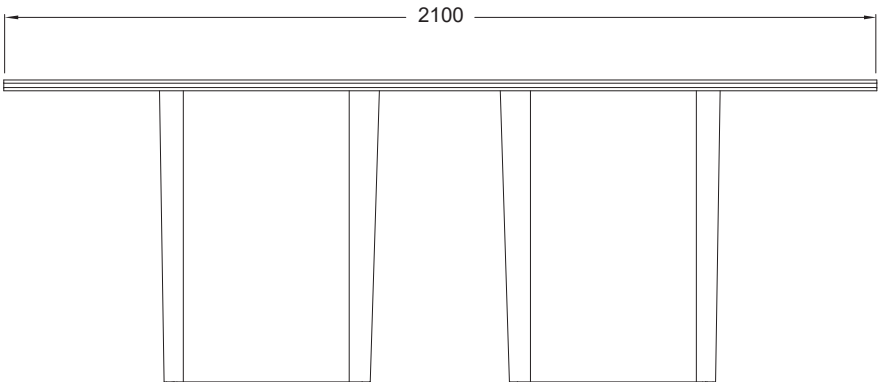
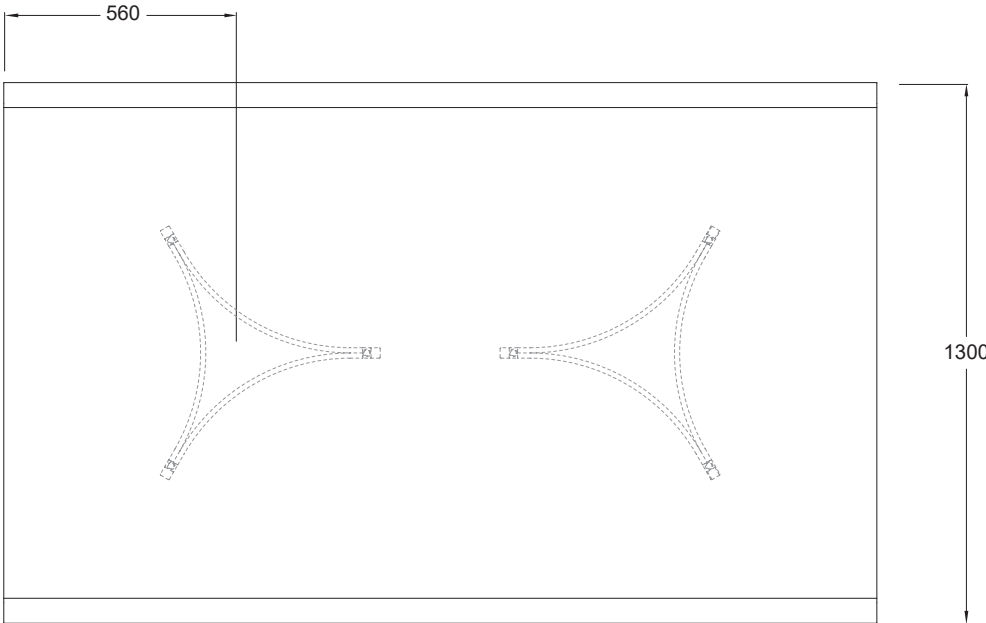
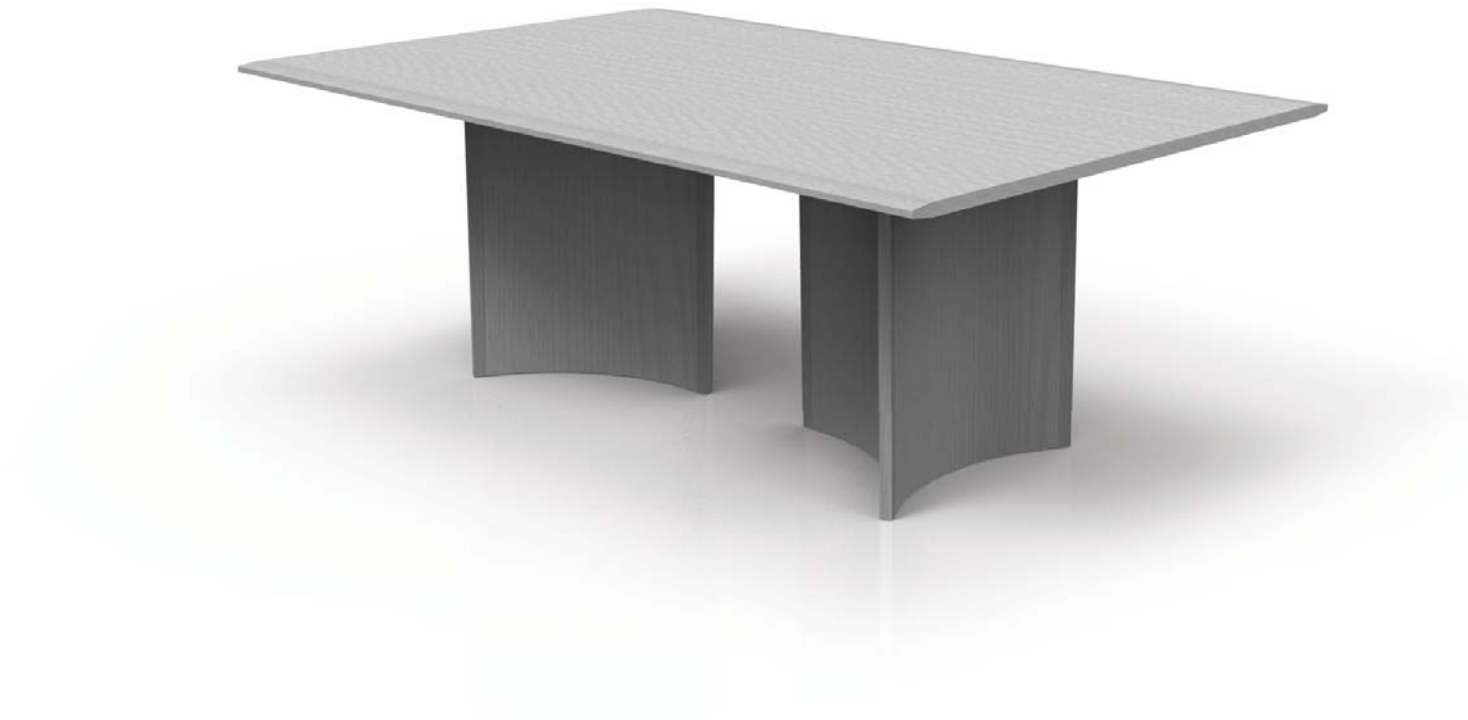

# CREVASSE TABLE RANGE

CV-TB.240x130

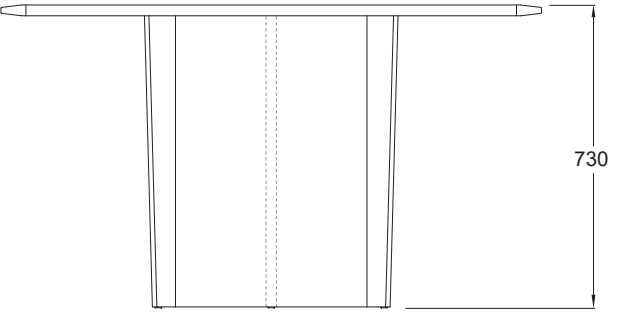
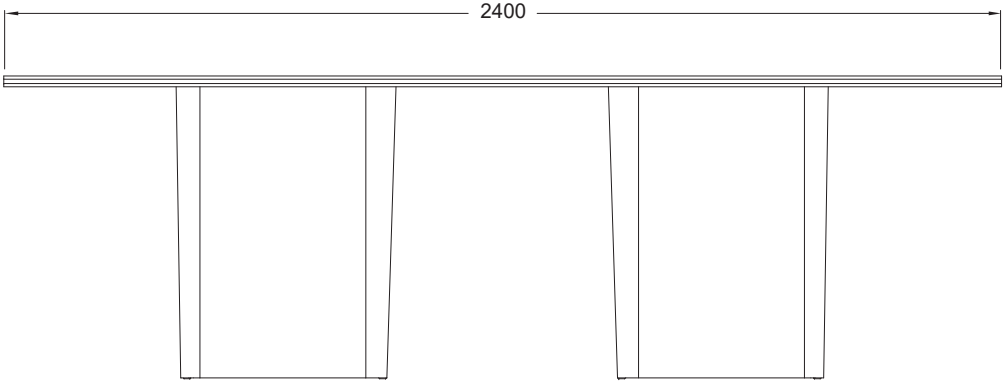
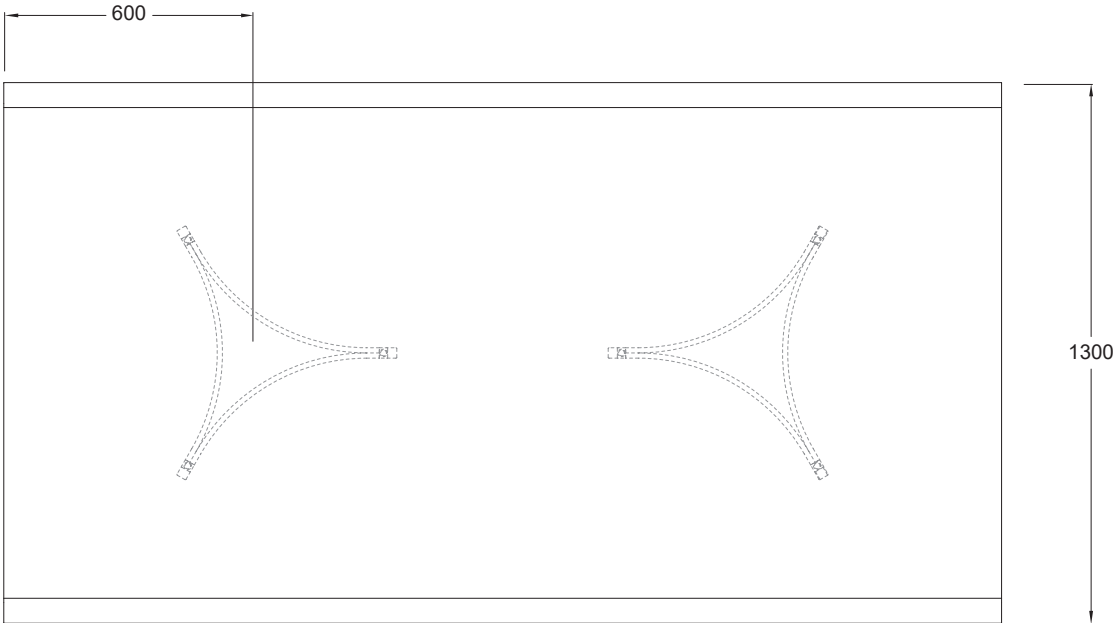
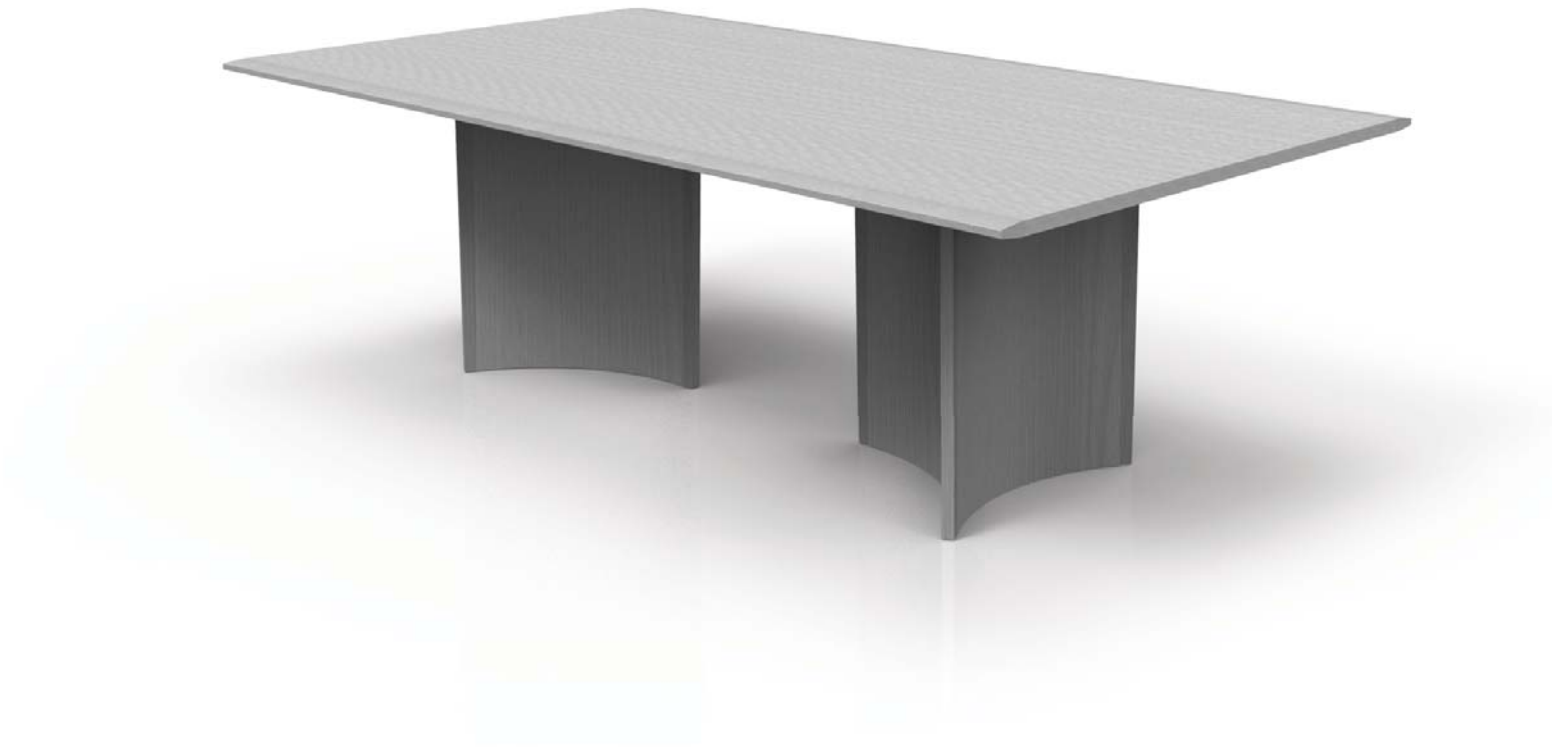

# CREVASSE TABLE RANGE

CV-TB.270x130

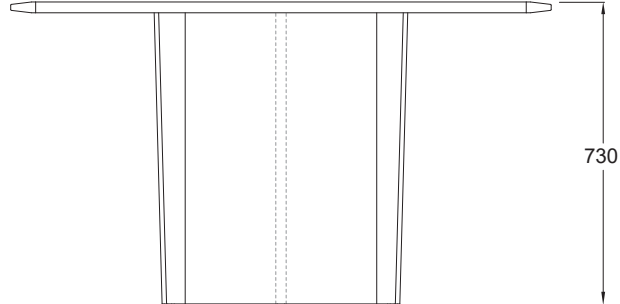
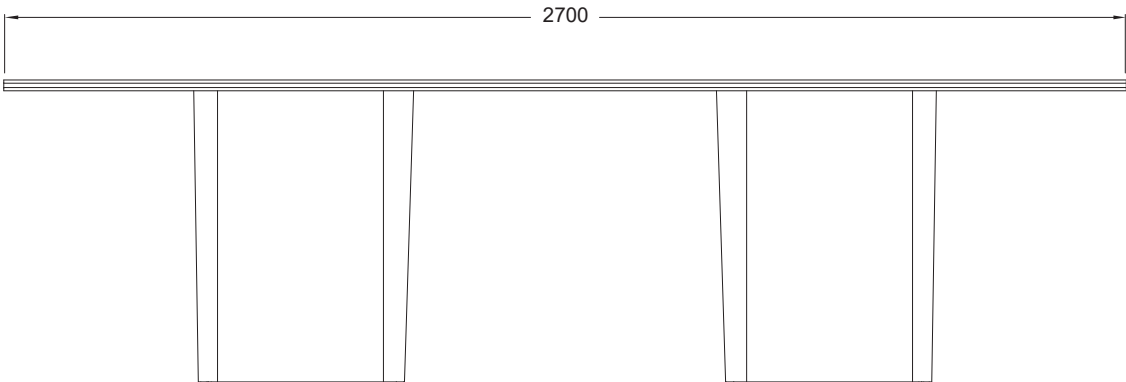
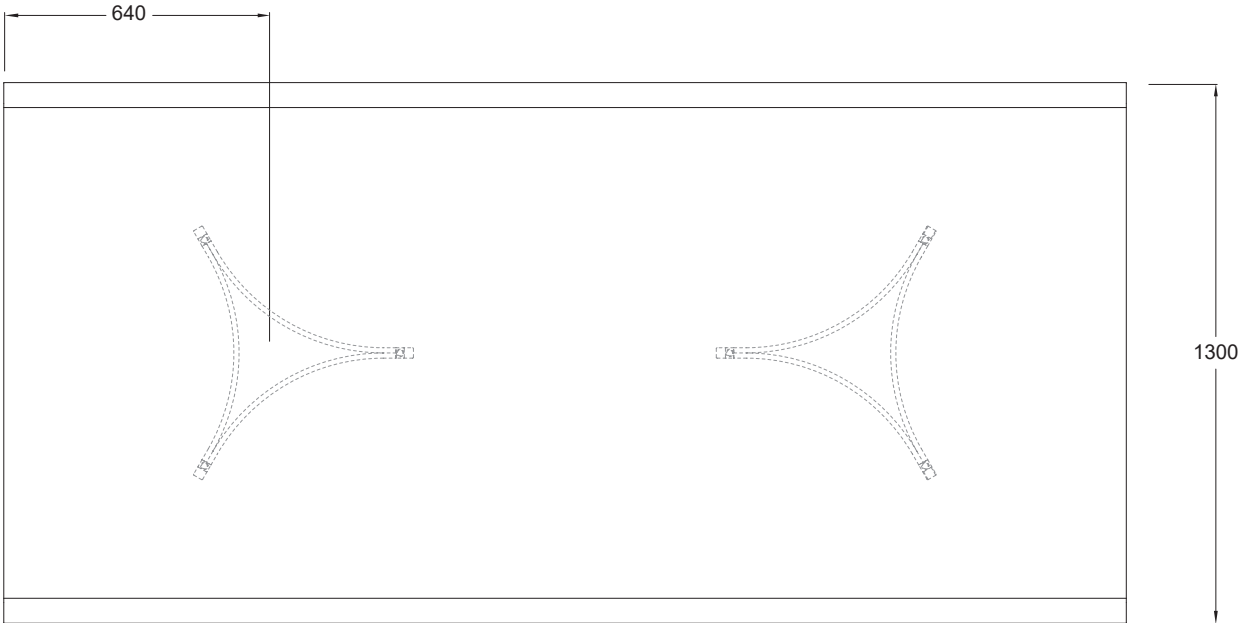

# CREVASSE TABLE RANGE

CV-TB.300x130

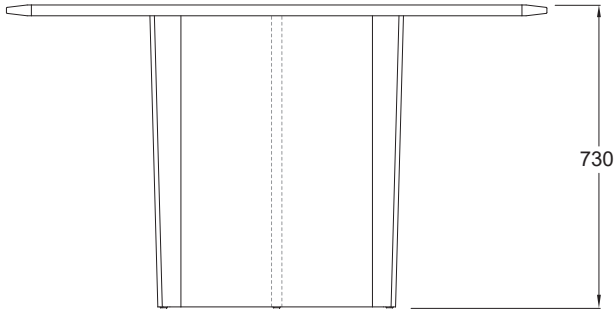
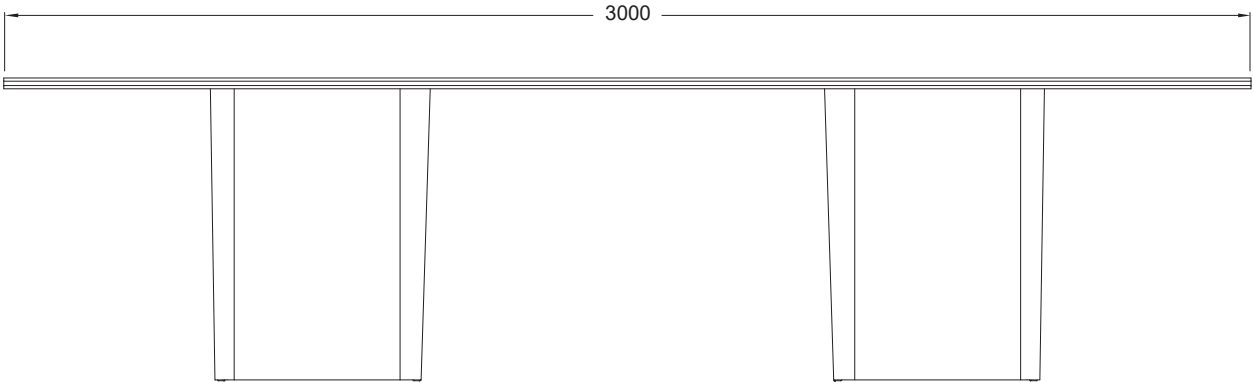
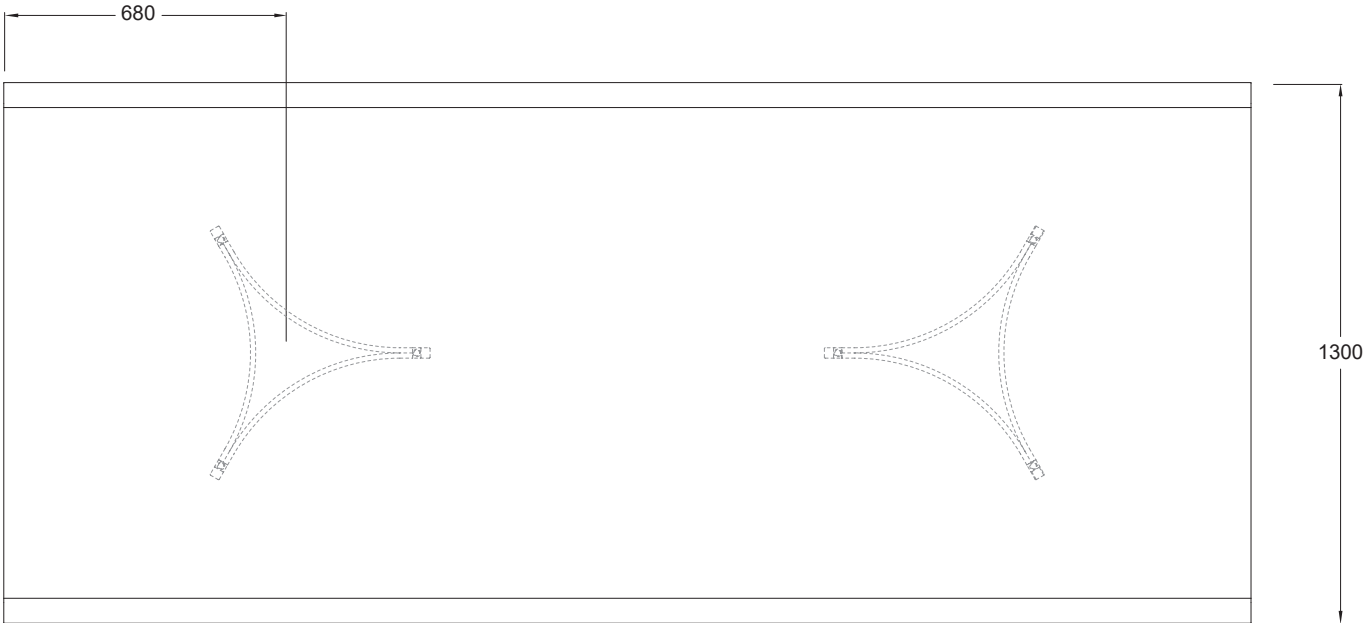

# CREVASSE TABLE RANGE

CV-TB.330x130

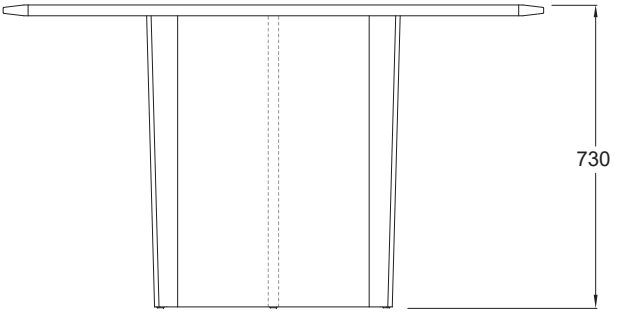
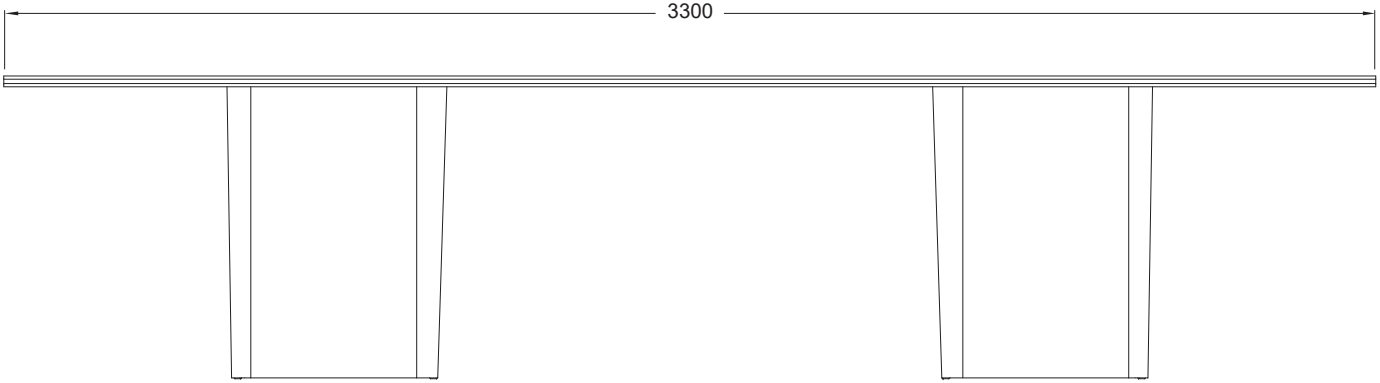
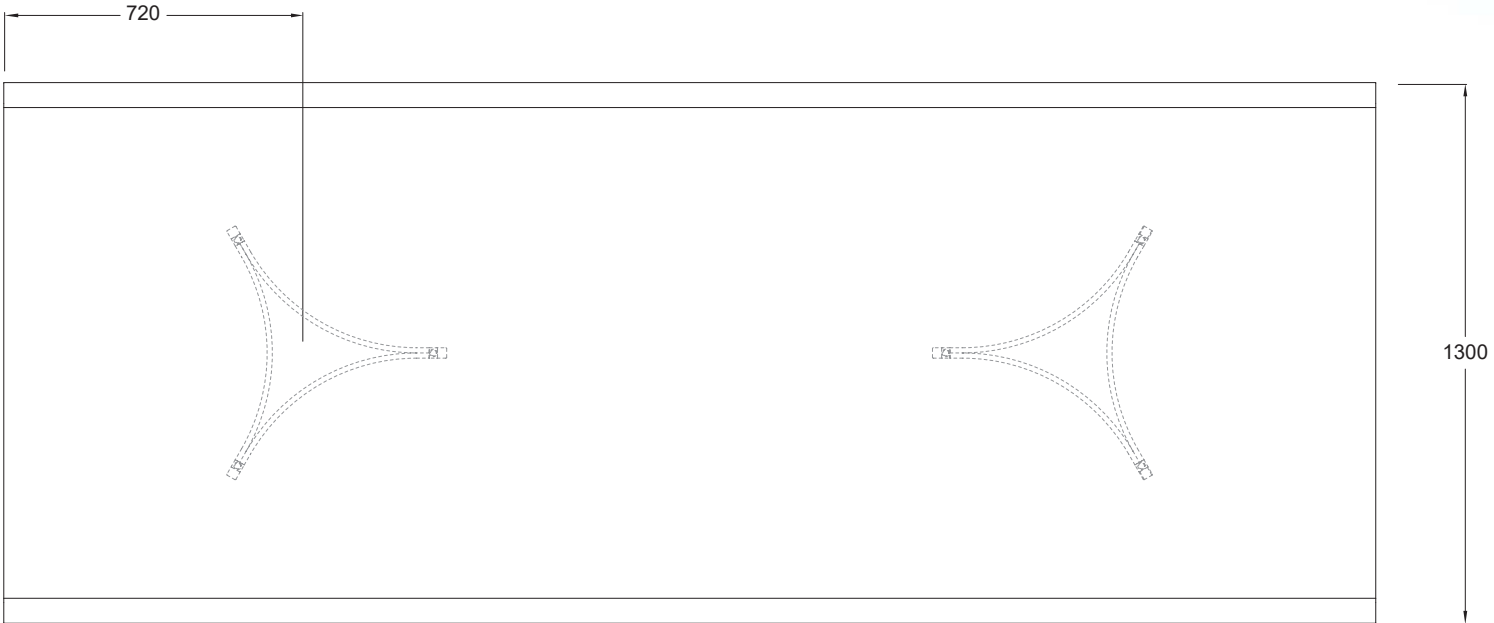

# CREVASSE TABLE RANGE

CV-TB.360x130

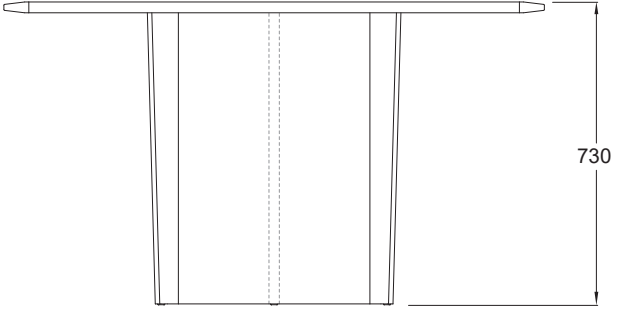
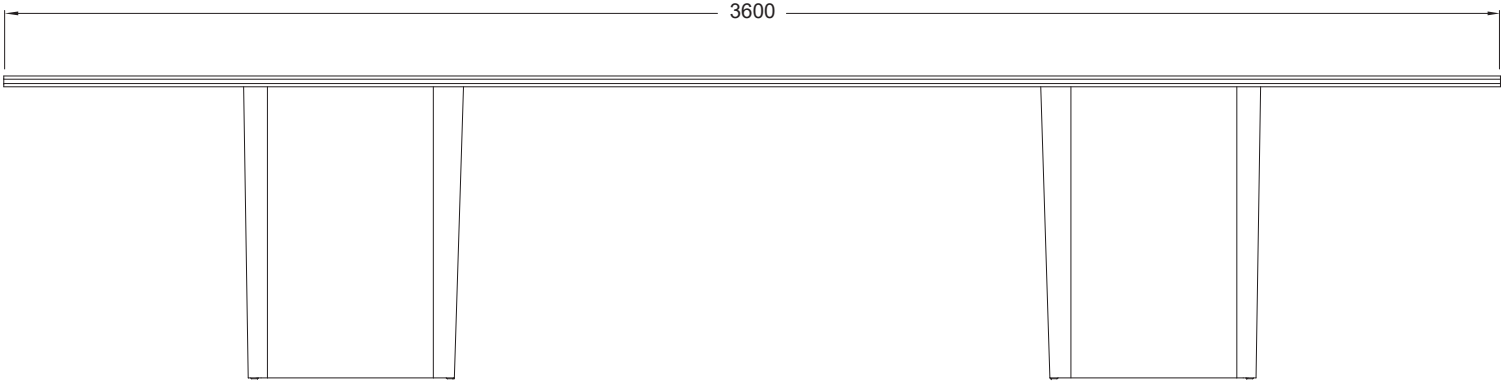
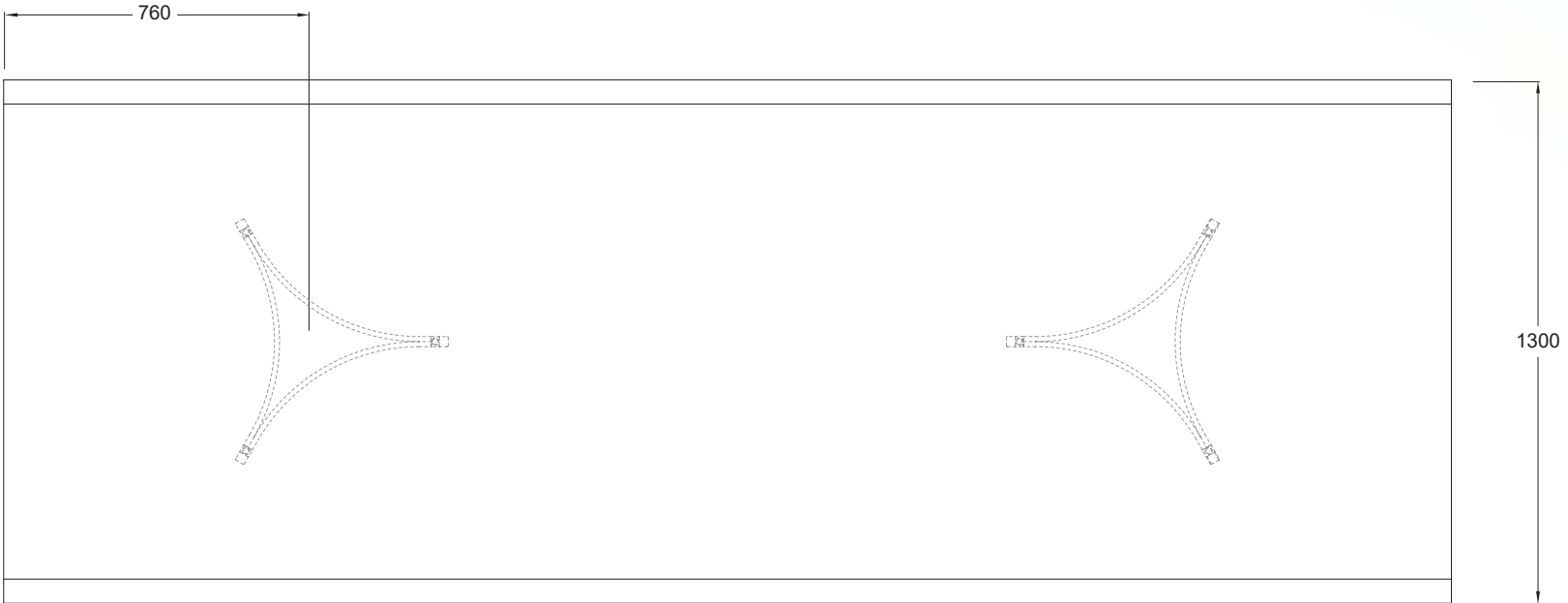
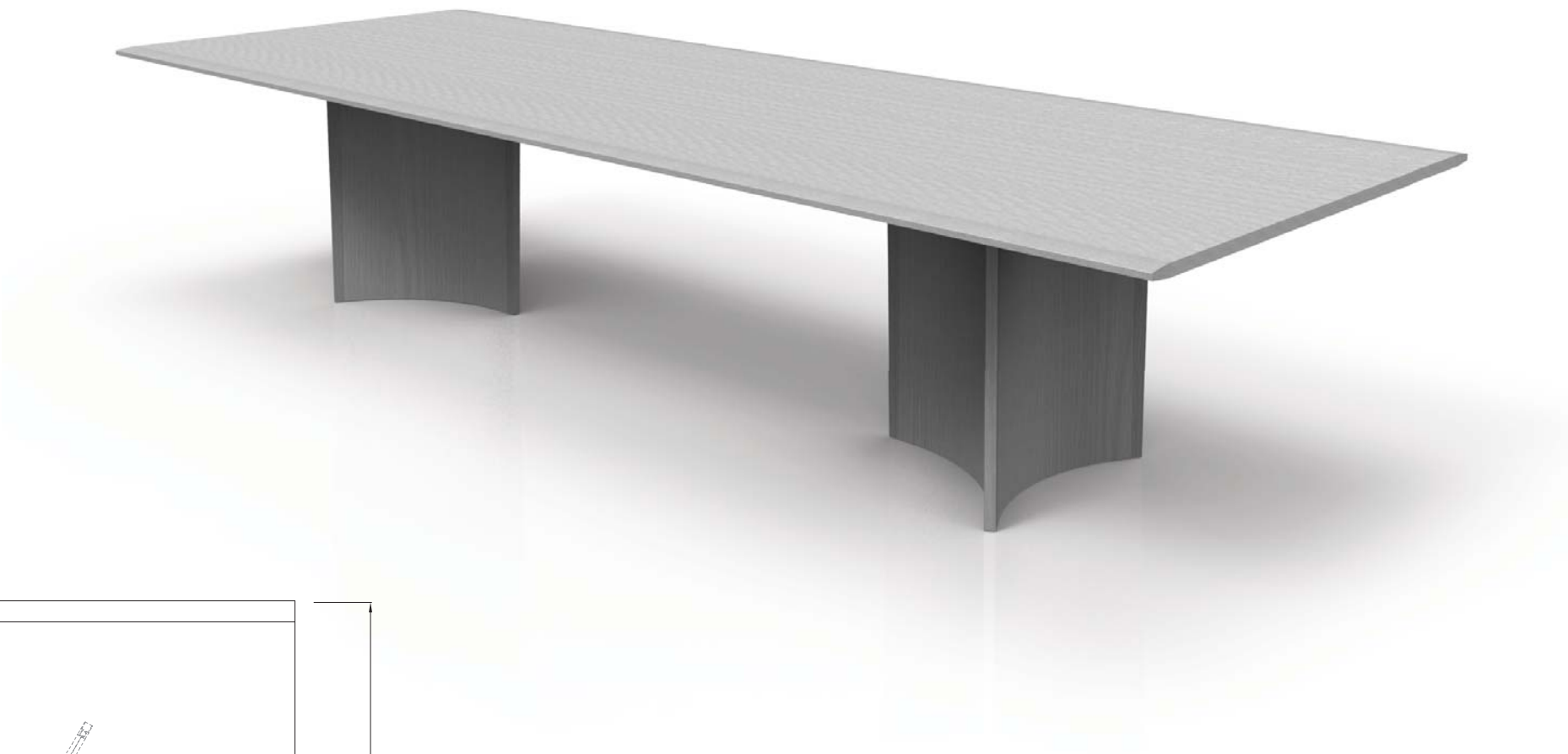

# CREVASSE TABLE RANGE

CV-TB.300x150

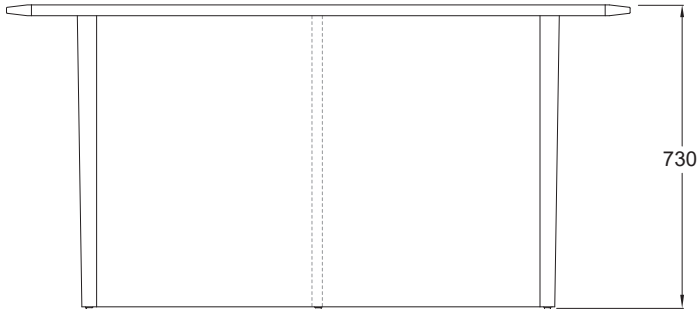
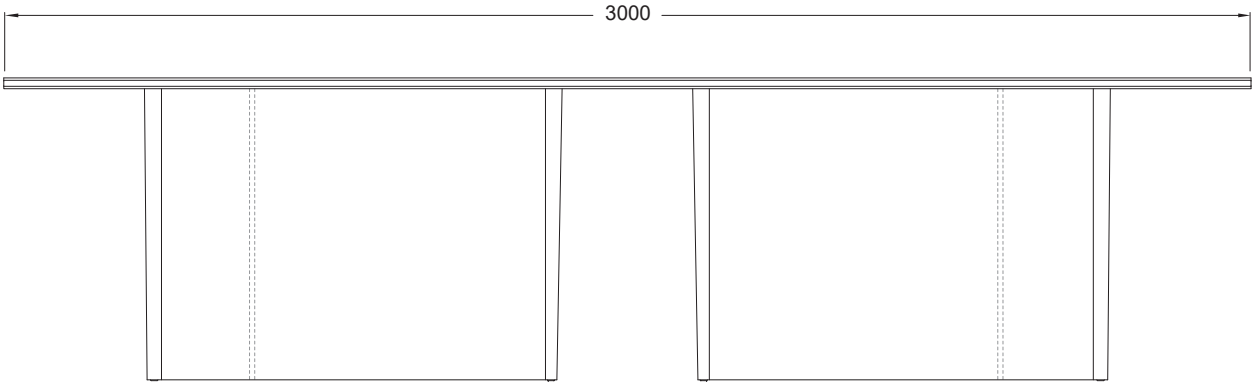
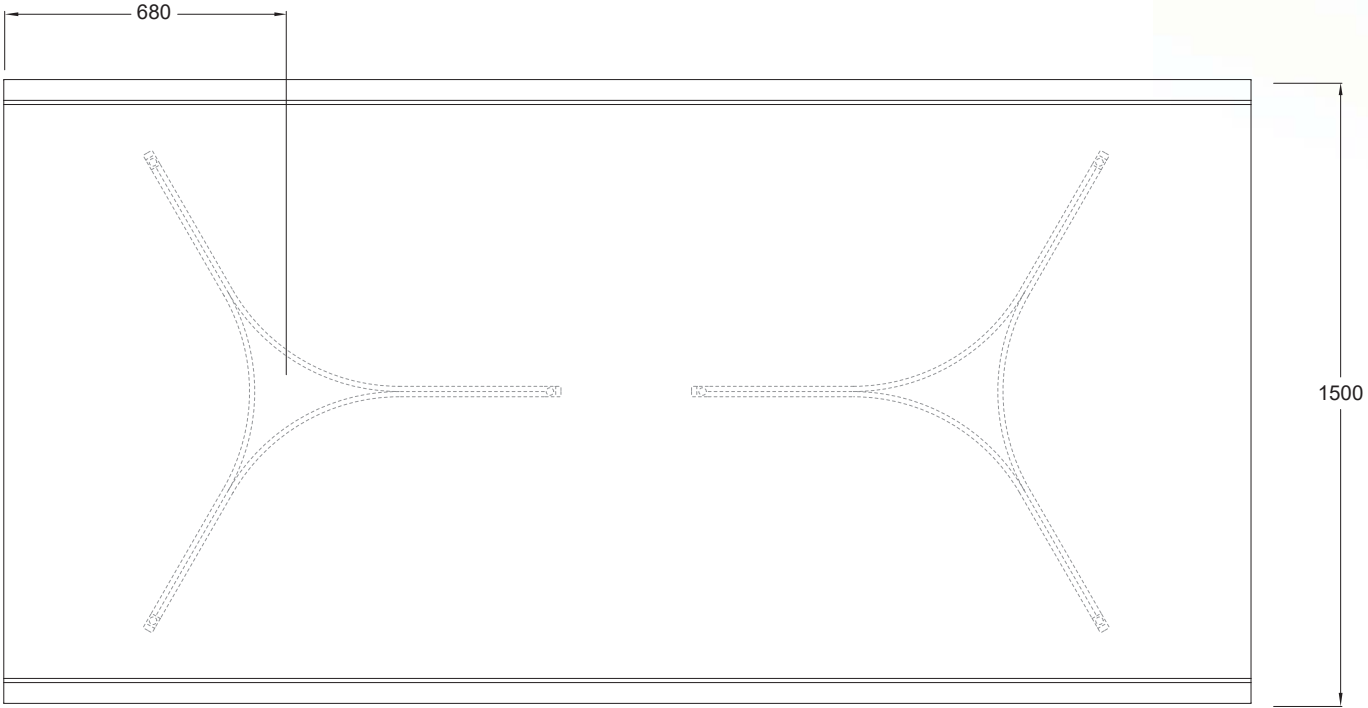
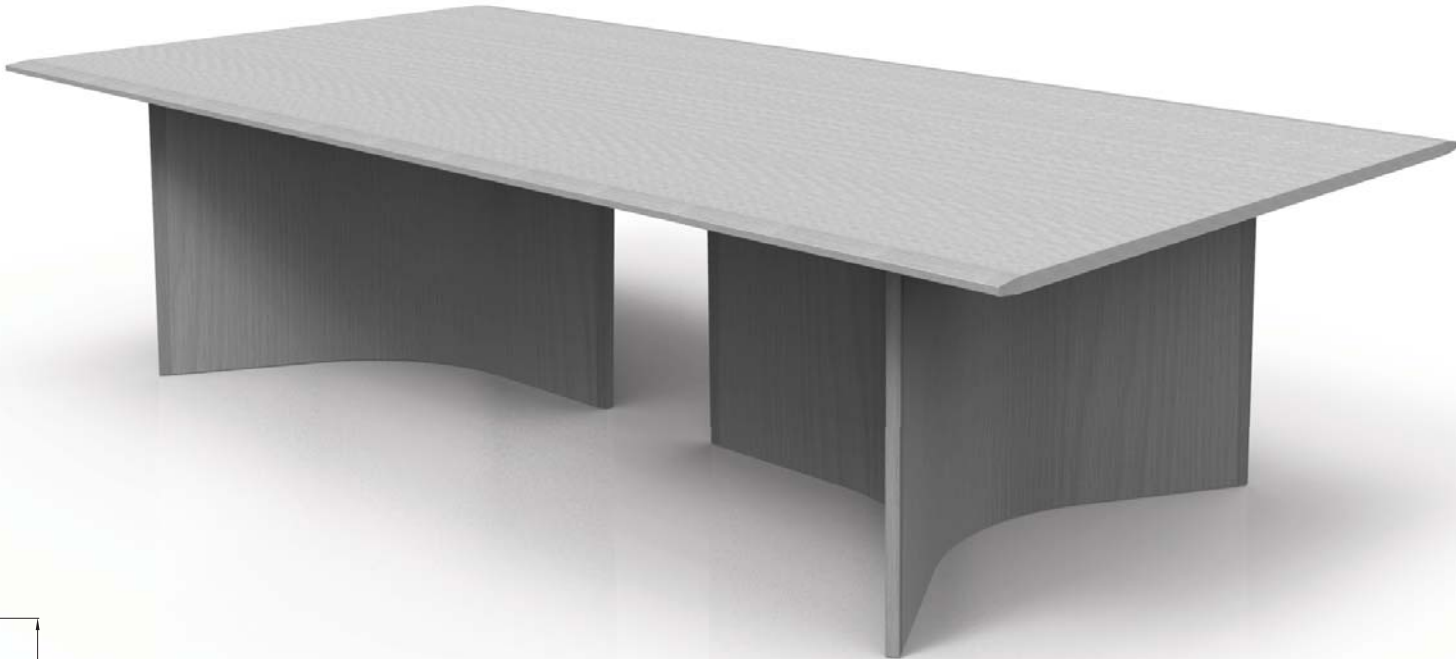

# CREVASSE TABLE RANGE

CV-TB.330x150

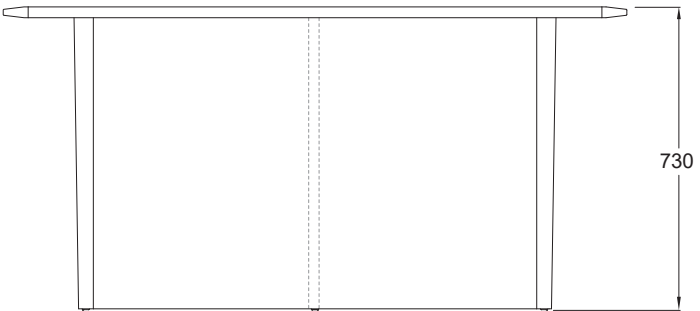
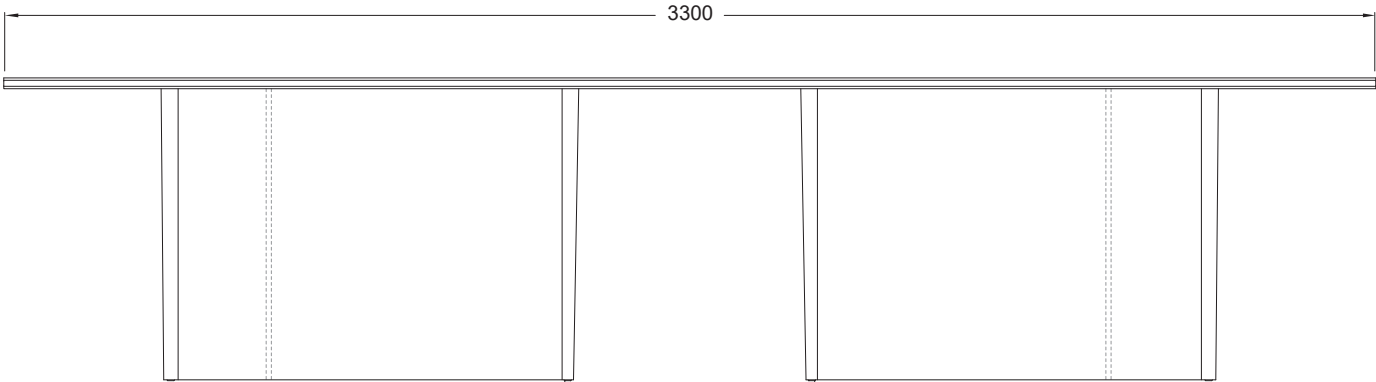
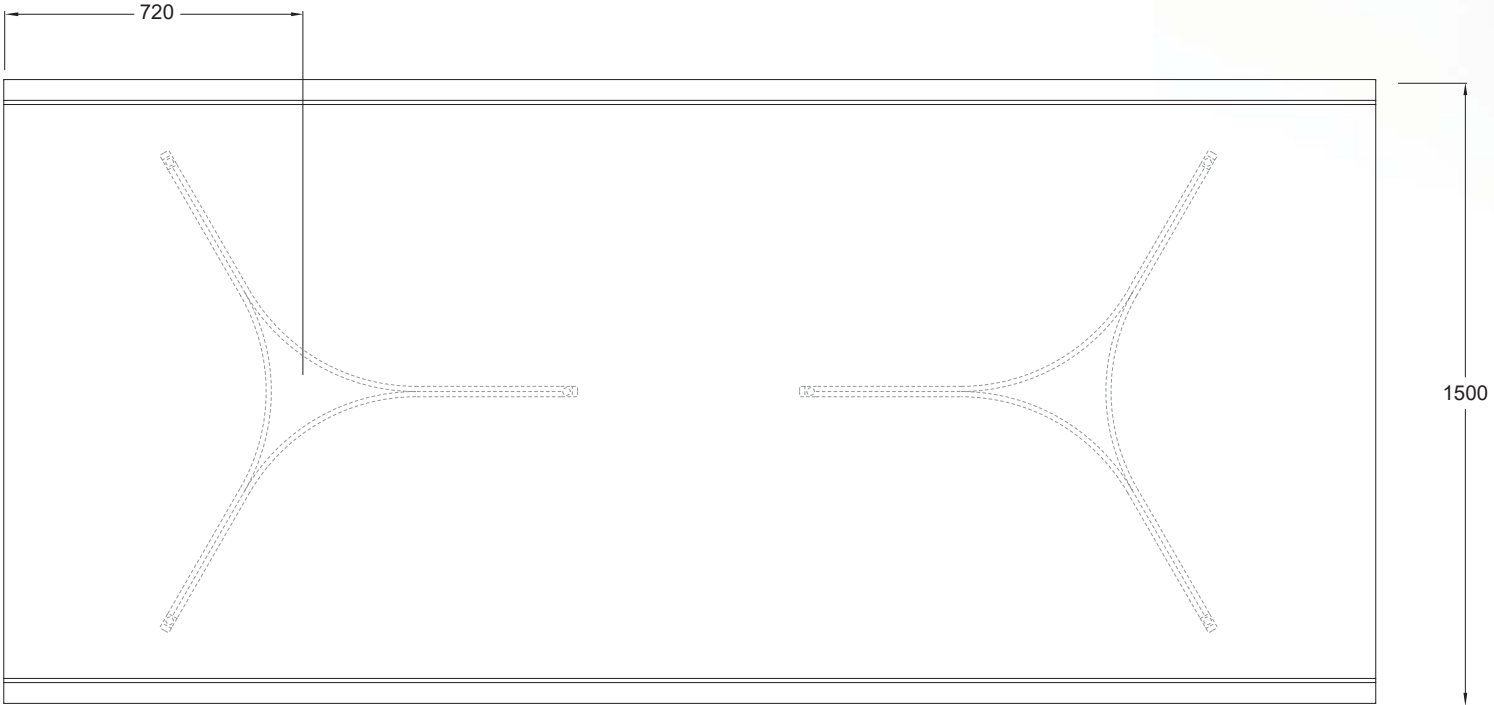



# CREVASSE TABLE RANGE

CV-TB.360x150

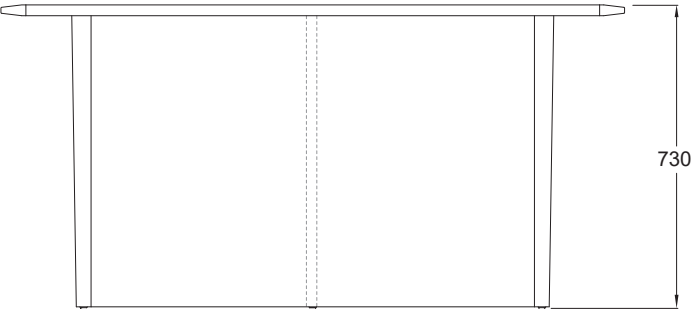
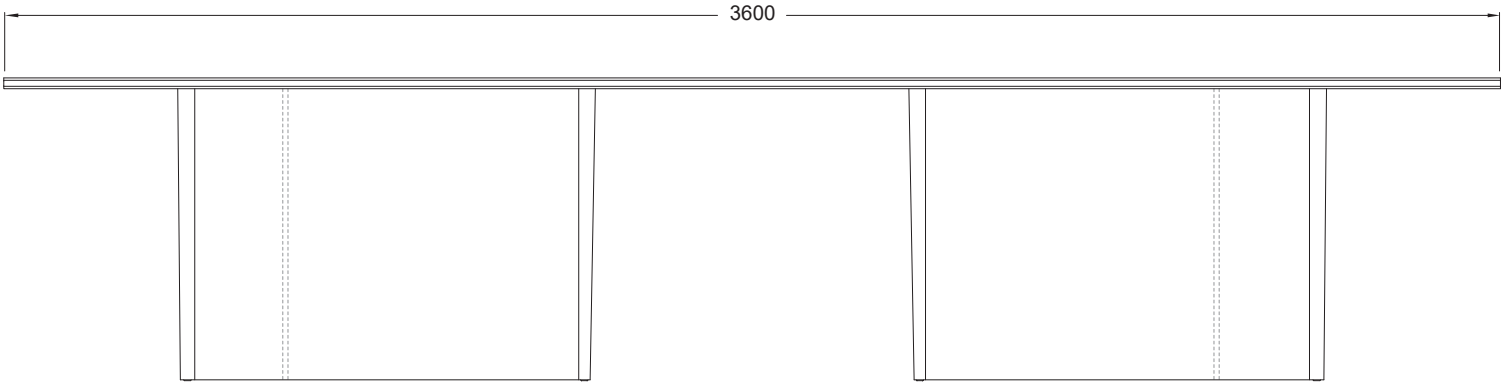
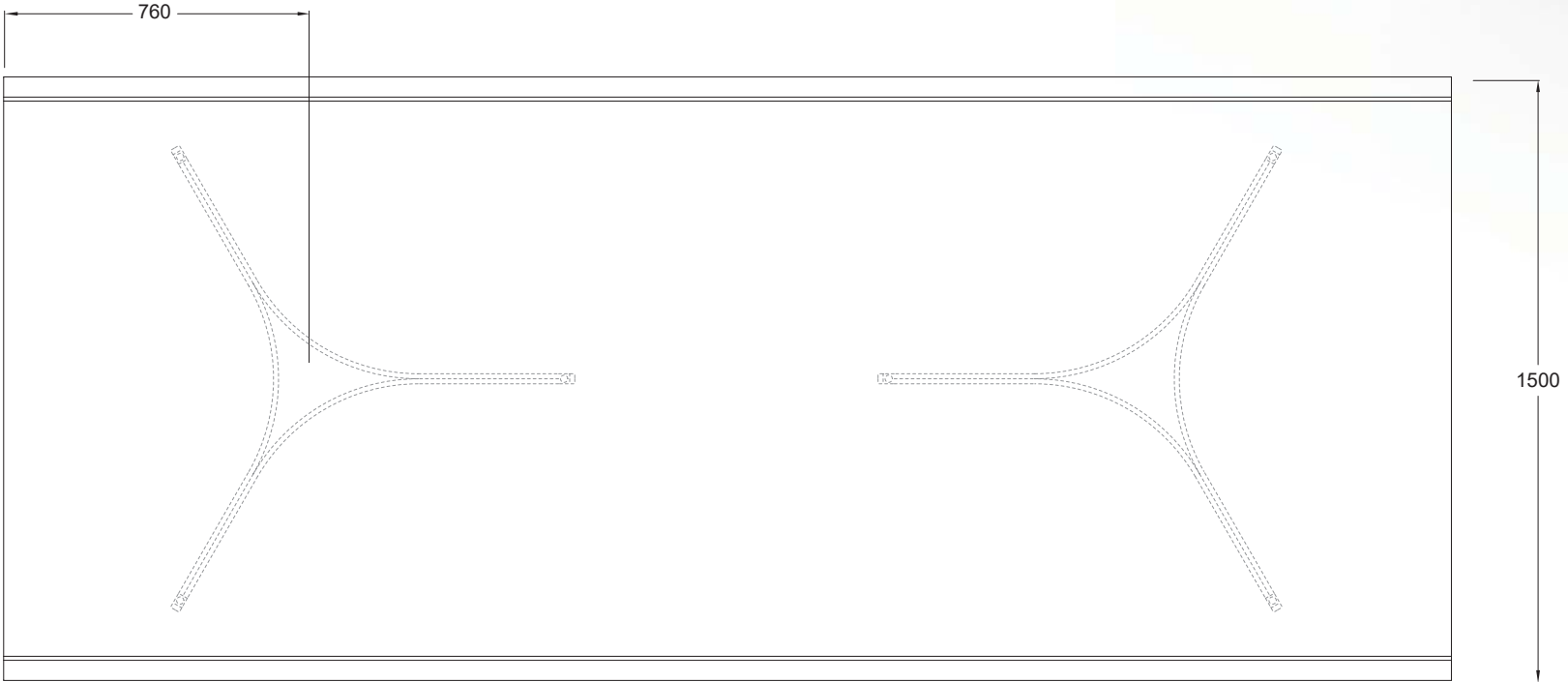
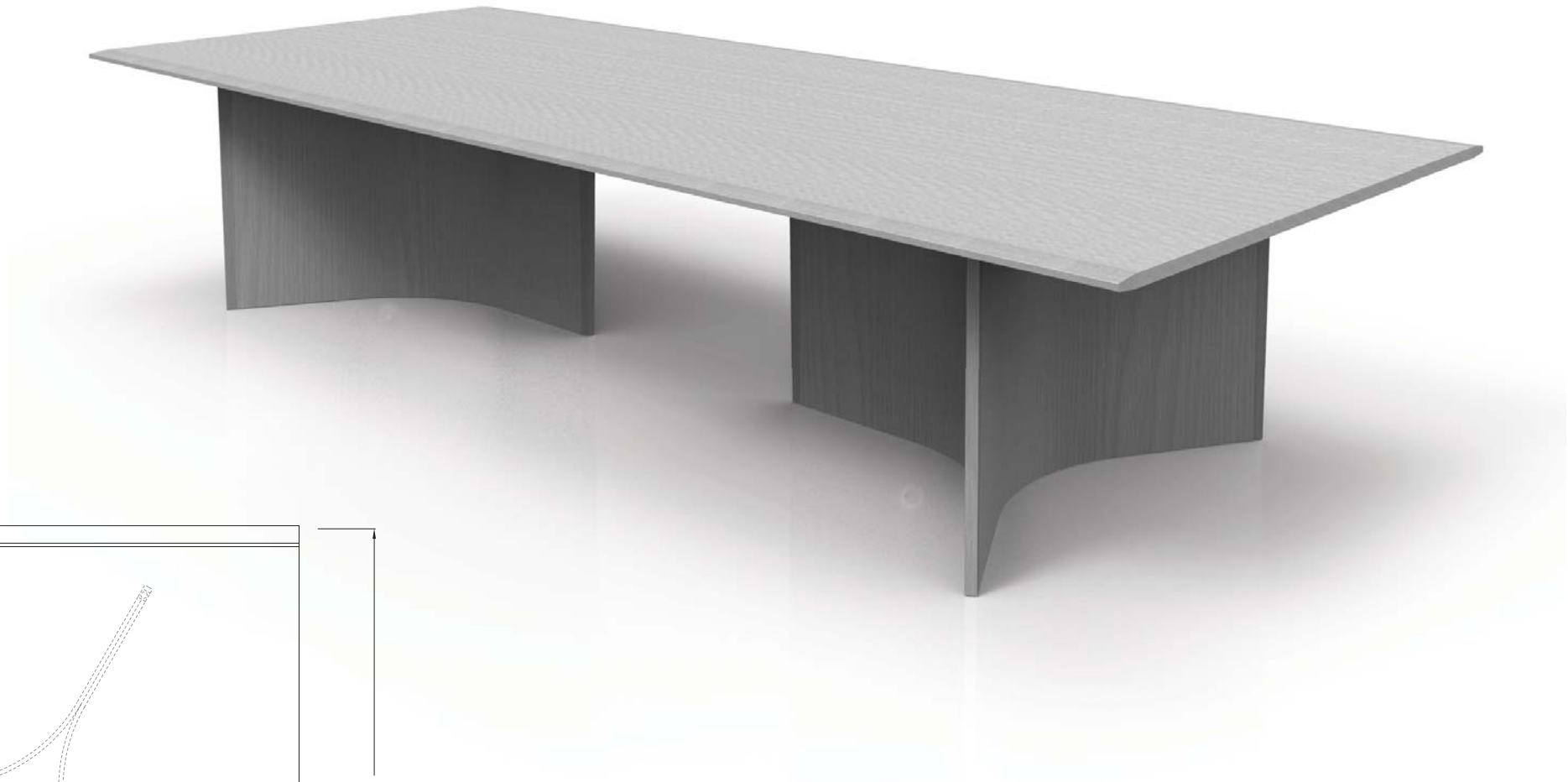

# CREVASSE TABLE RANGE

CV-TB.300x180

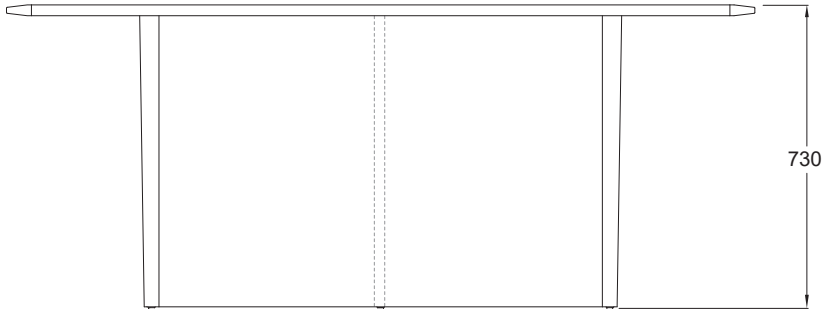
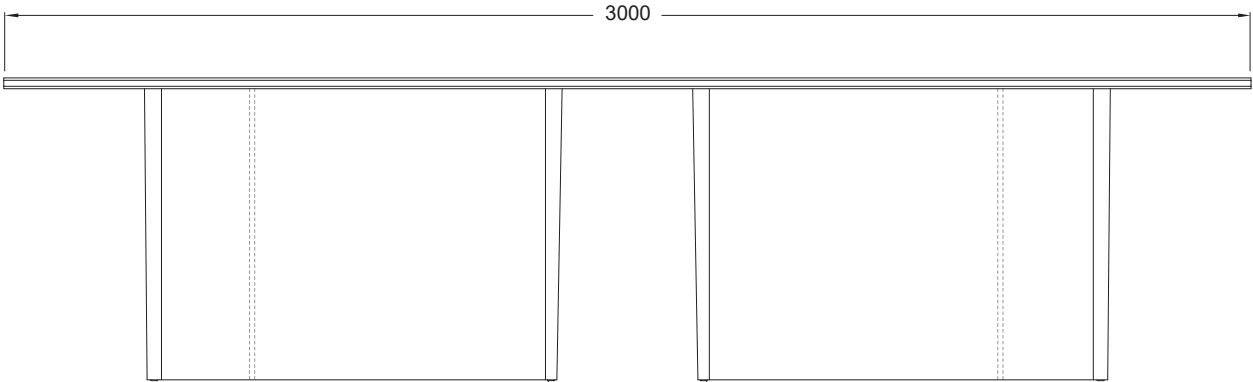
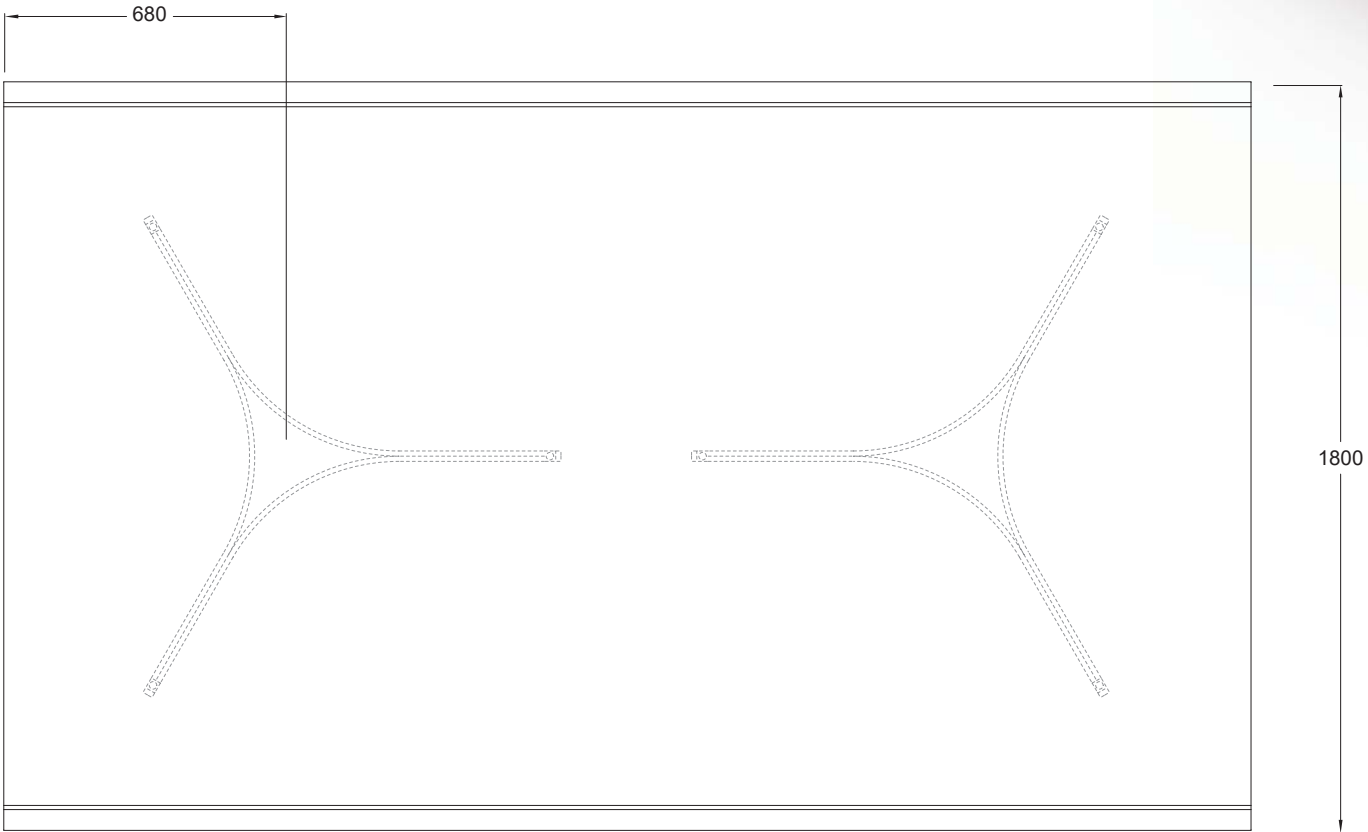

# CREVASSE TABLE RANGE

CV-TB.330x180

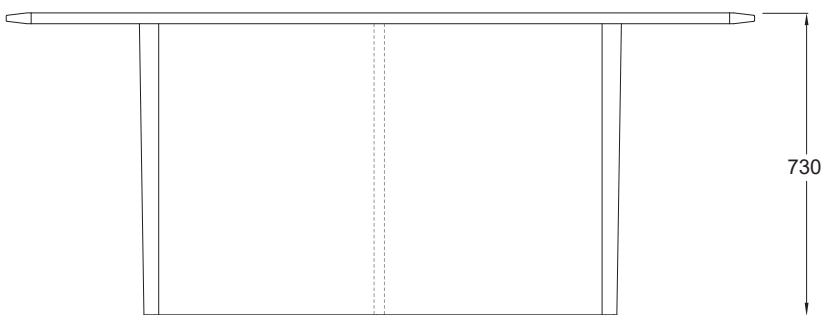
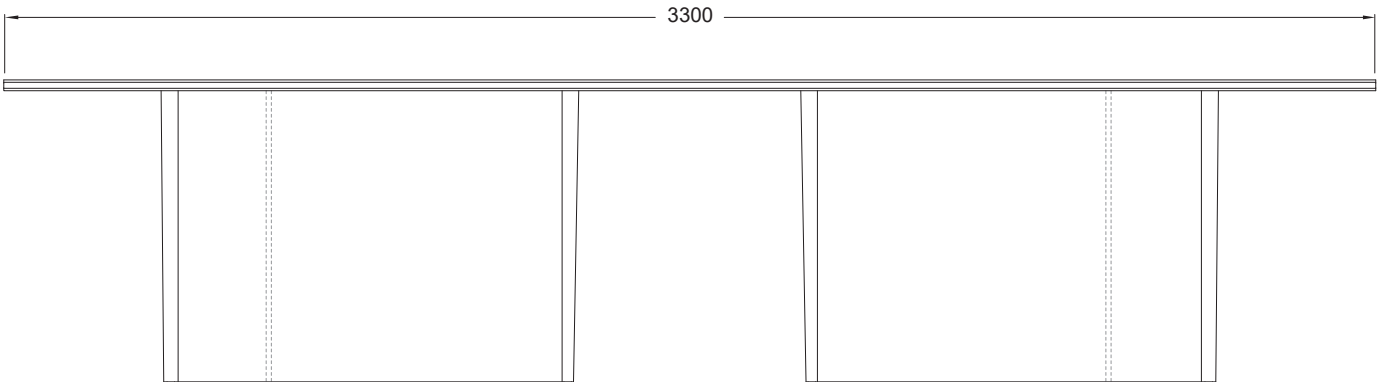
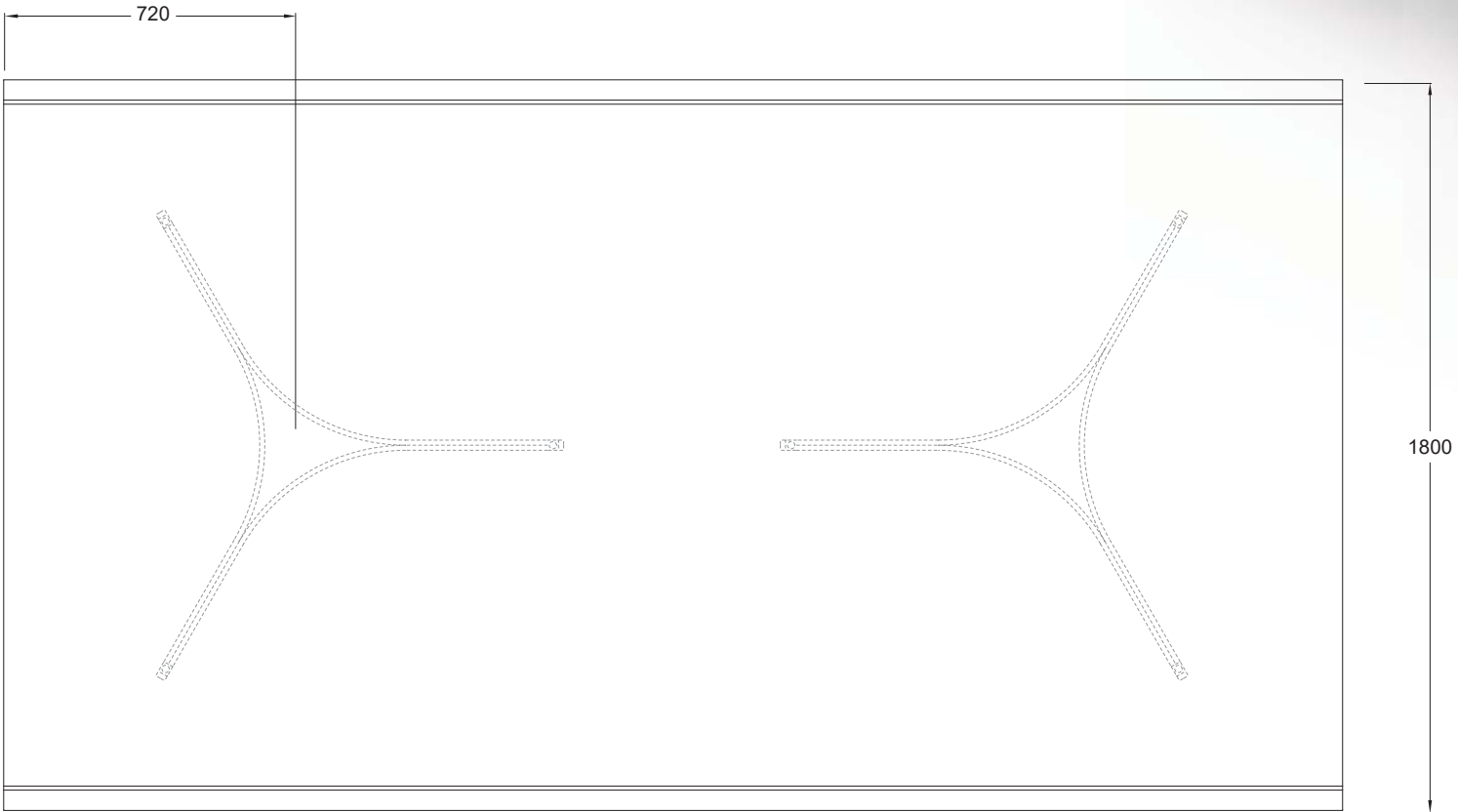
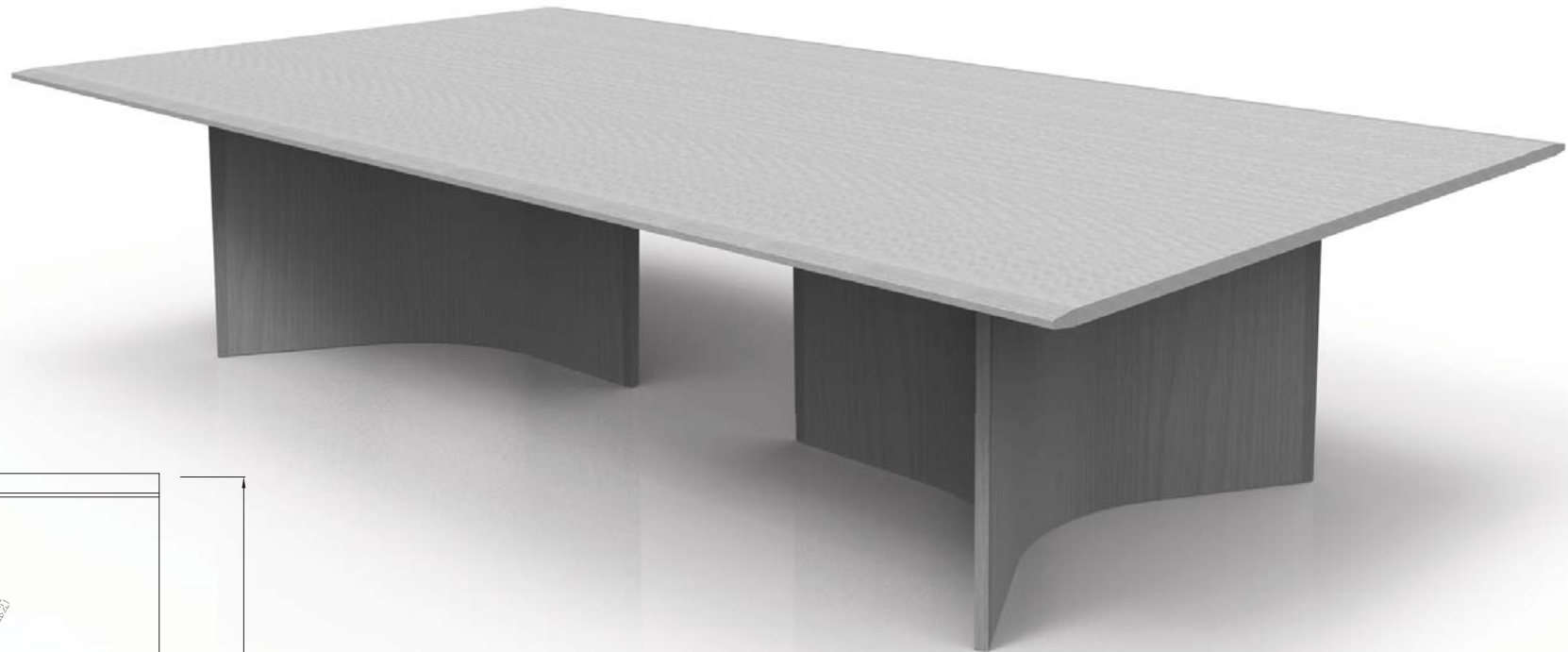

# CREVASSE TABLE RANGE

CV-TB.360x180

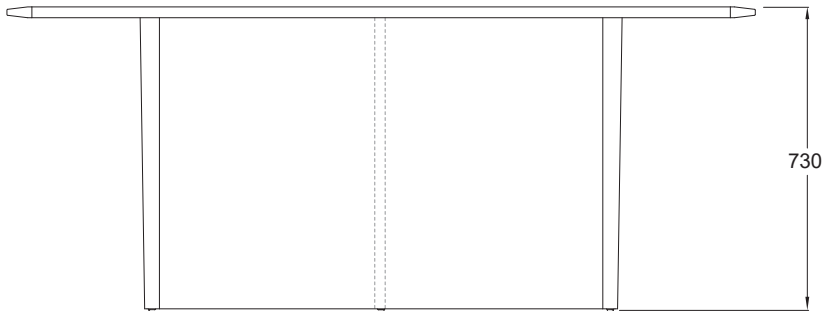
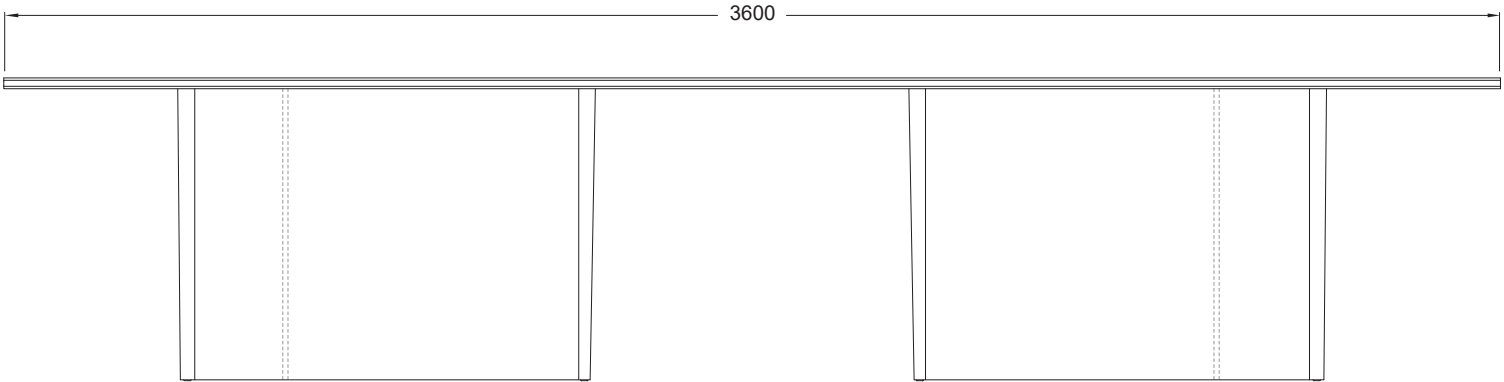
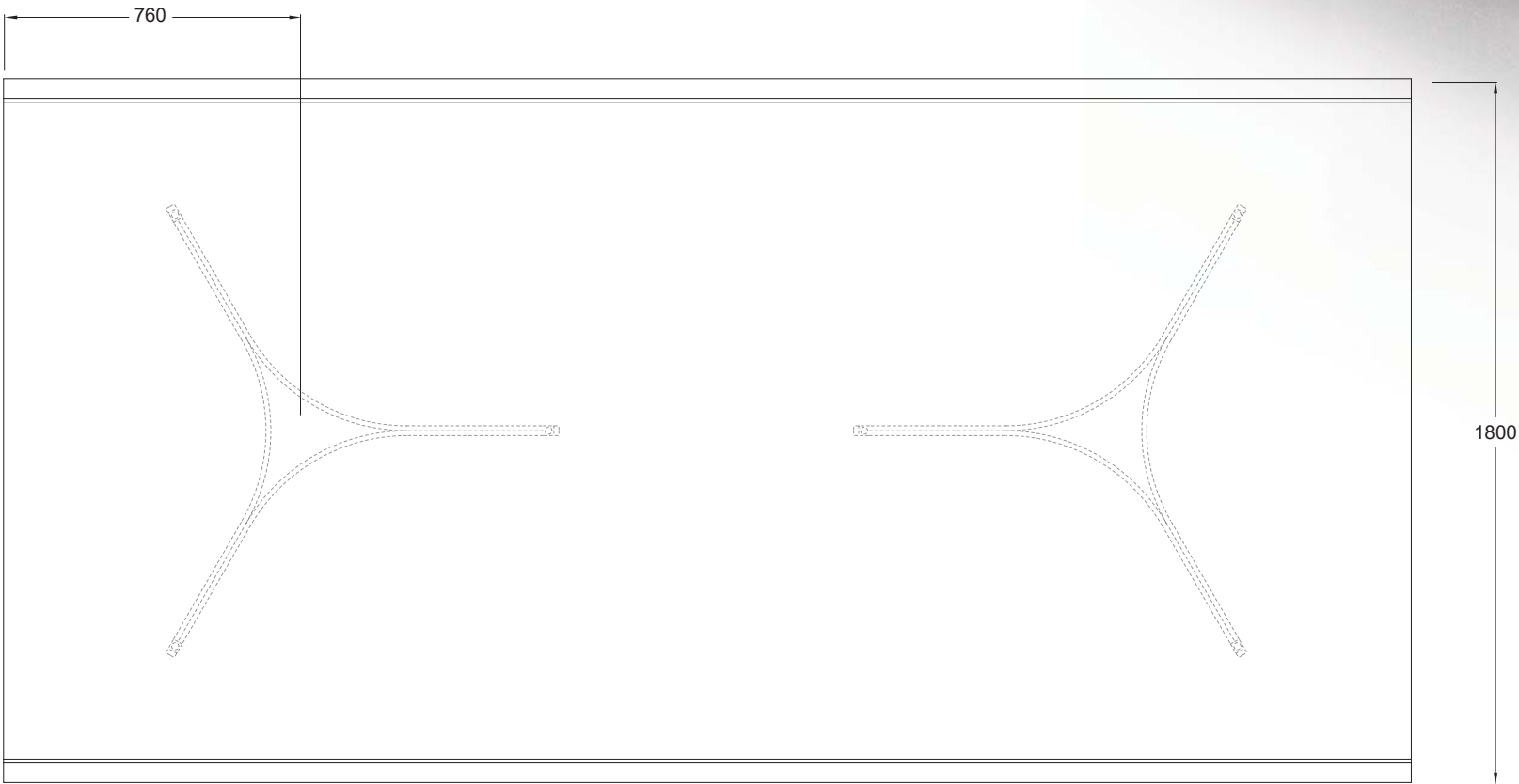
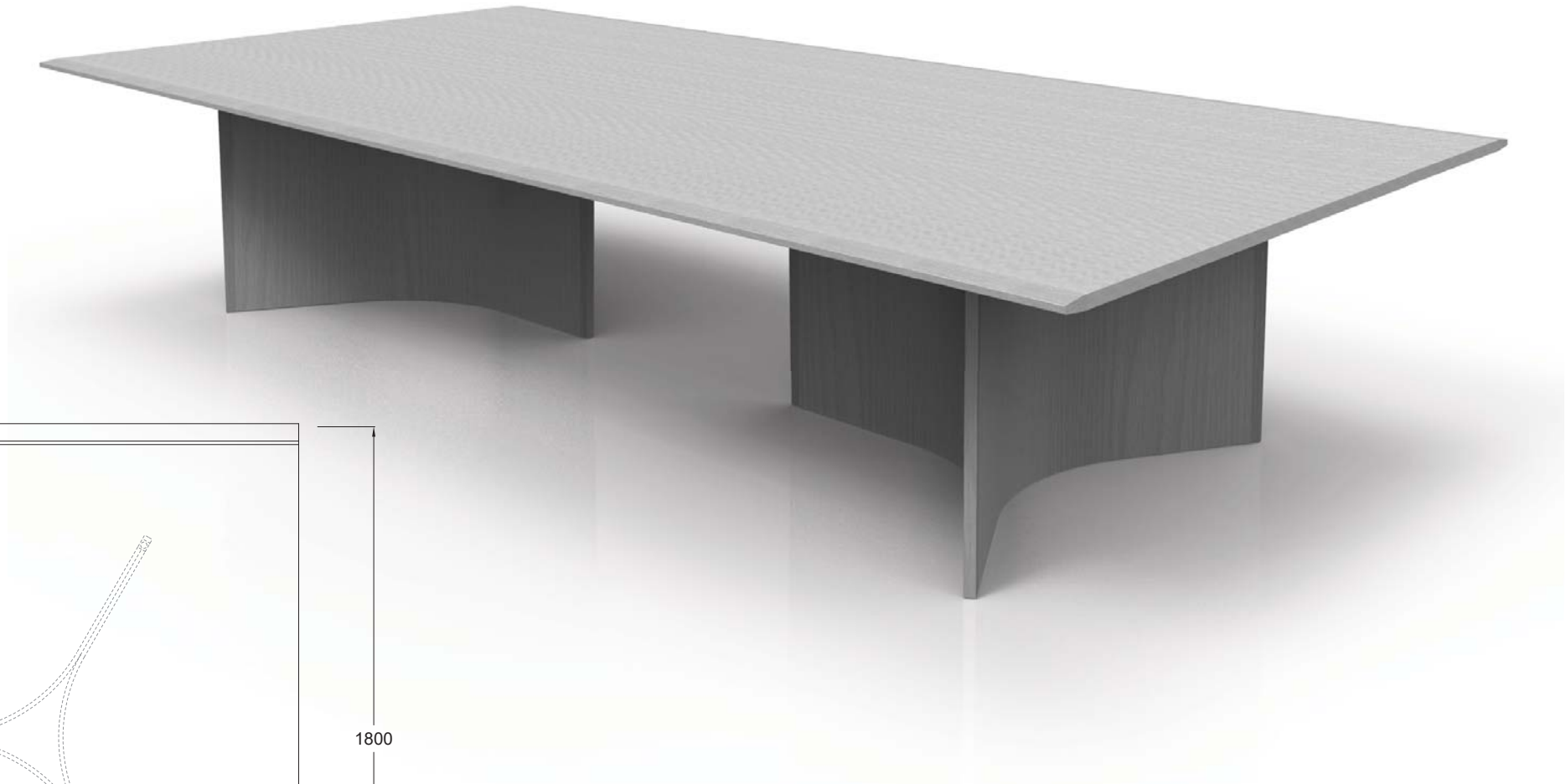

# CREVASSE BAR TABLE RANGE

CV-BTB[90].180x100

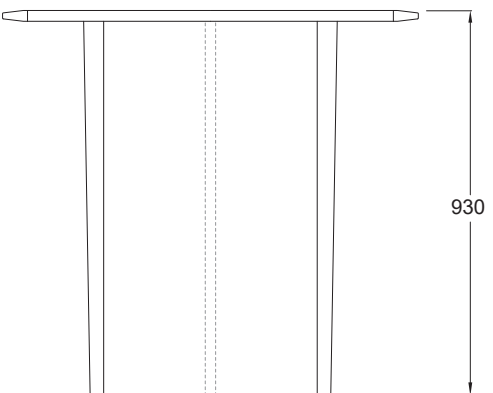
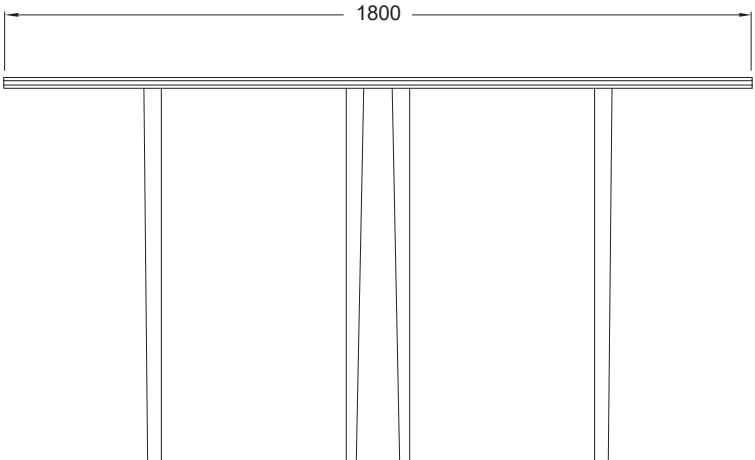
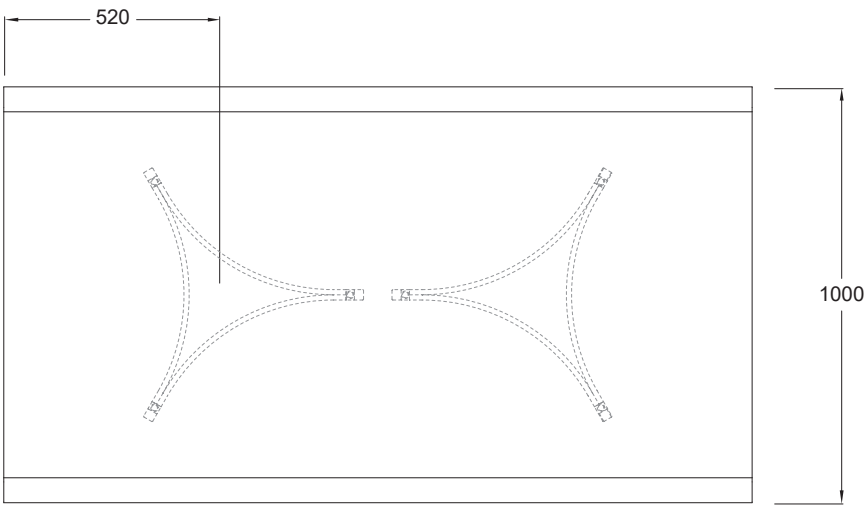

# CREVASSE BAR TABLE RANGE

CV-BTB[90].210x100

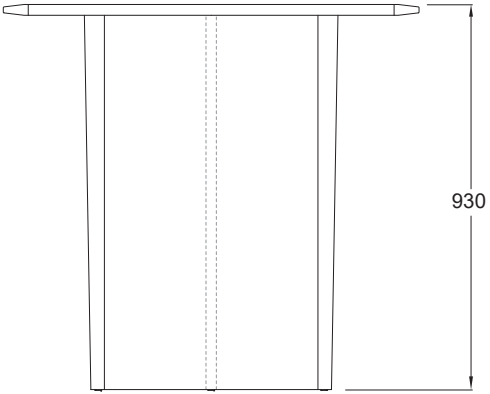
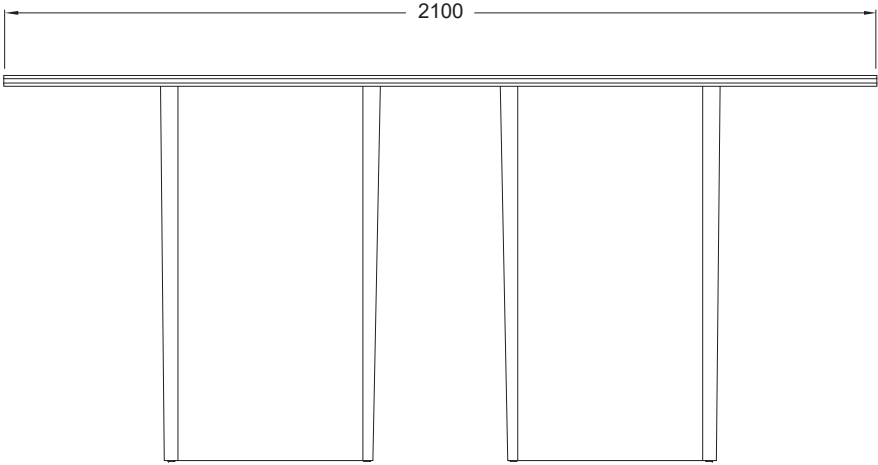
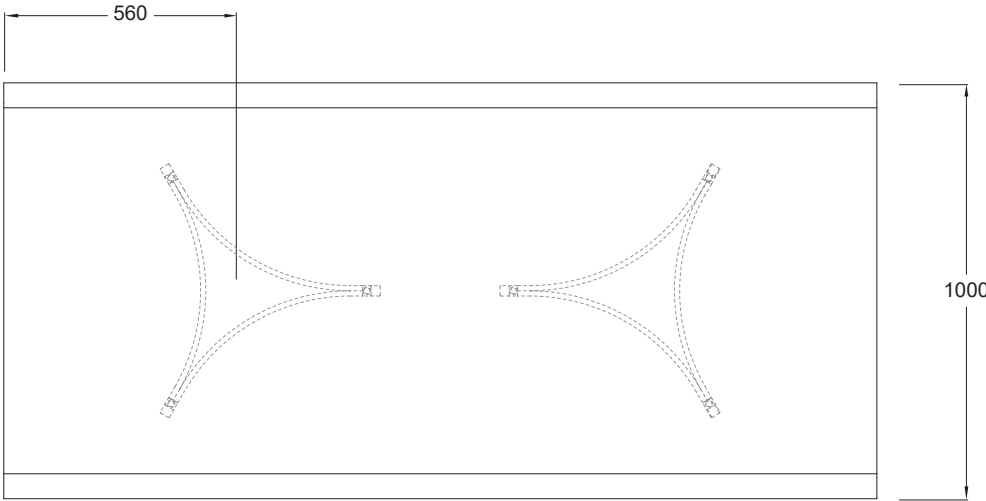

# CREVASSE BAR TABLE RANGE

CV-BTB[90].240x100

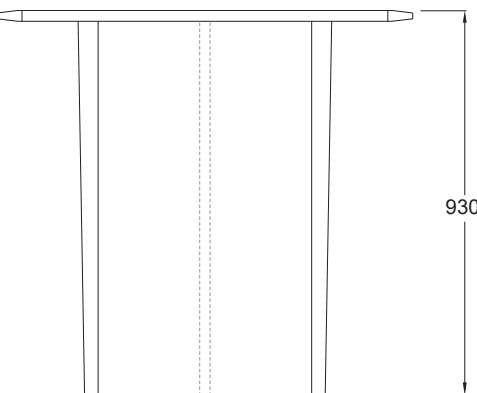
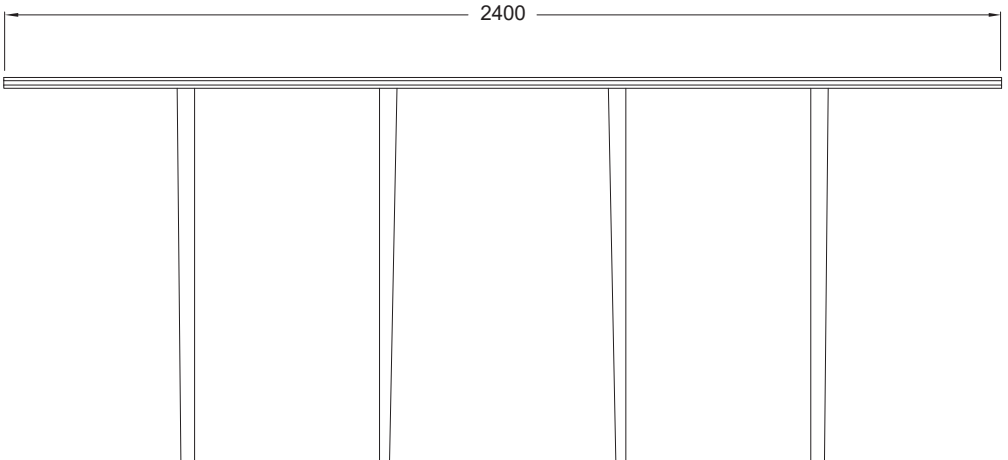
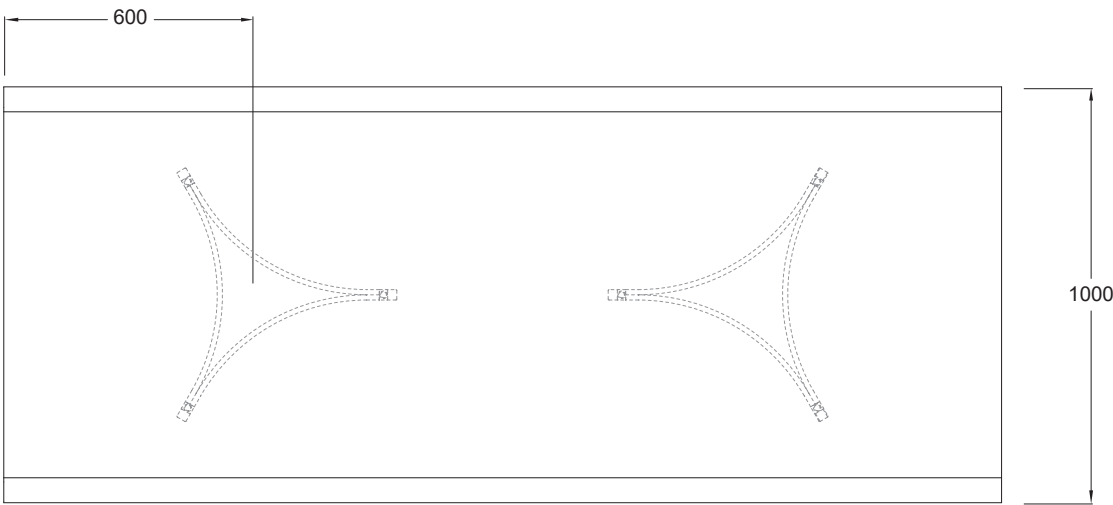

# CREVASSE BAR TABLE RANGE

CV-BTB[90].270x100

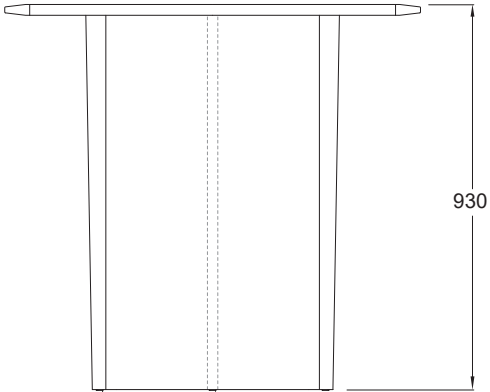
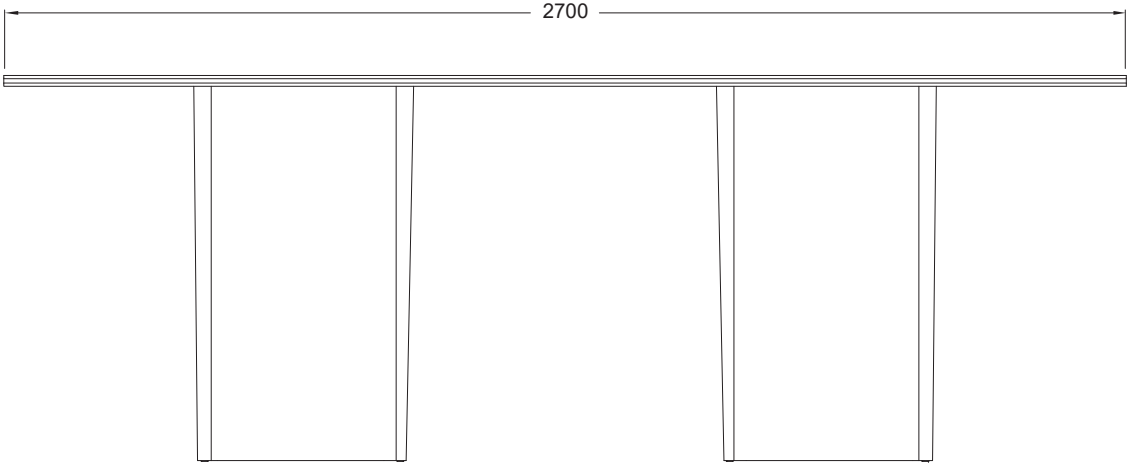
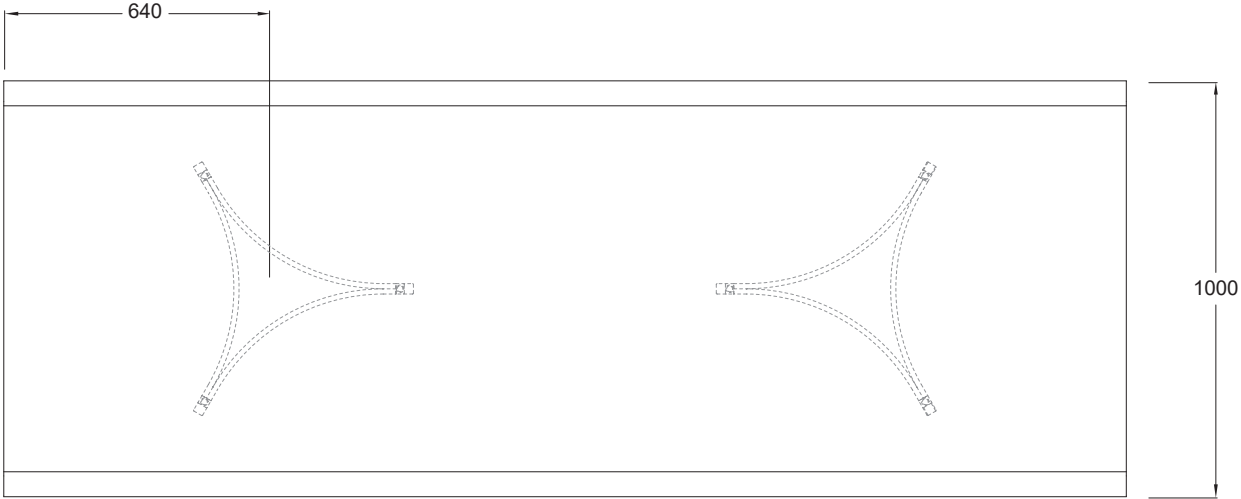



# CREVASSE BAR TABLE RANGE

CV-BTB[90].300x100

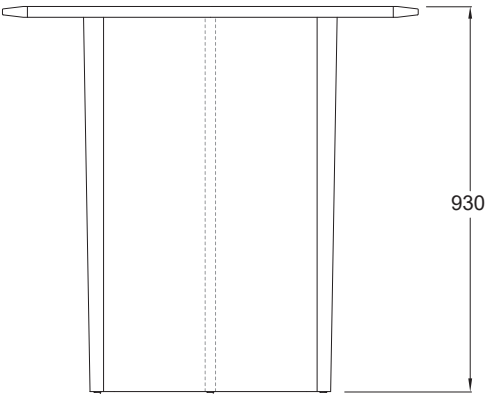
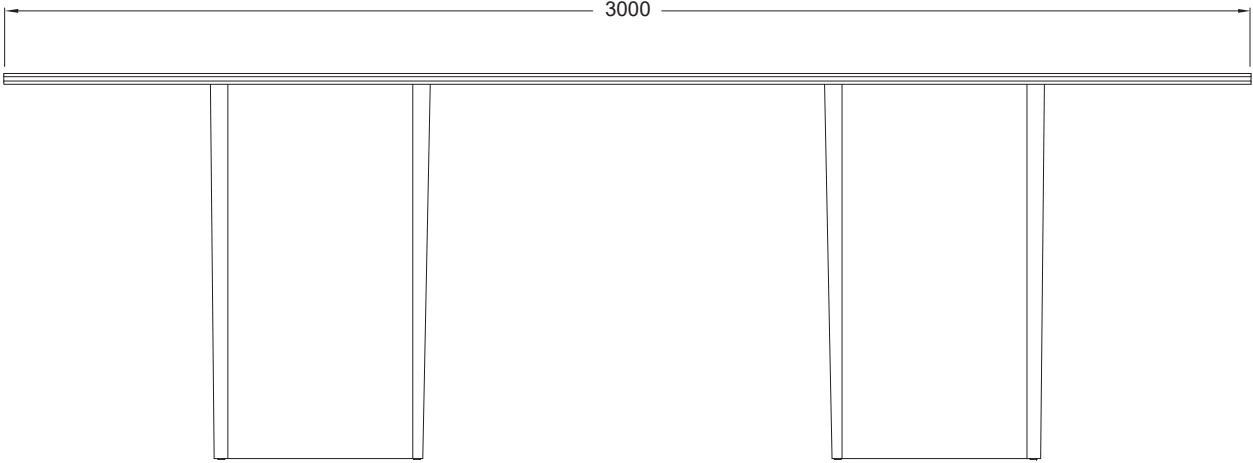
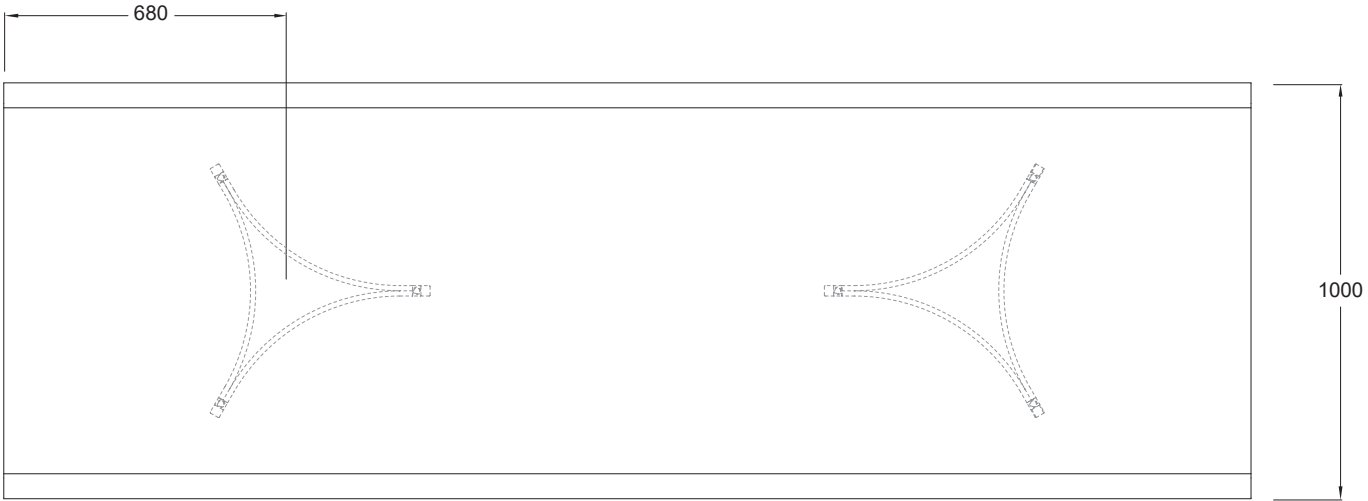

# CREVASSE BAR TABLE RANGE

CV-BTB[90].330x100

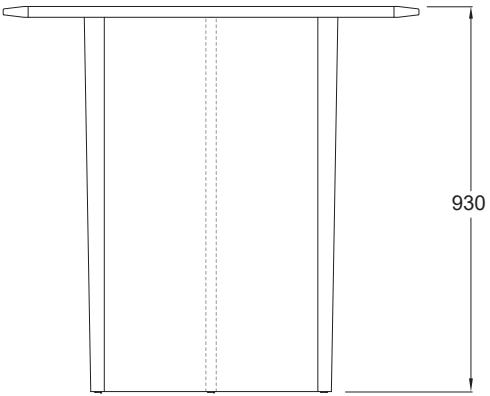
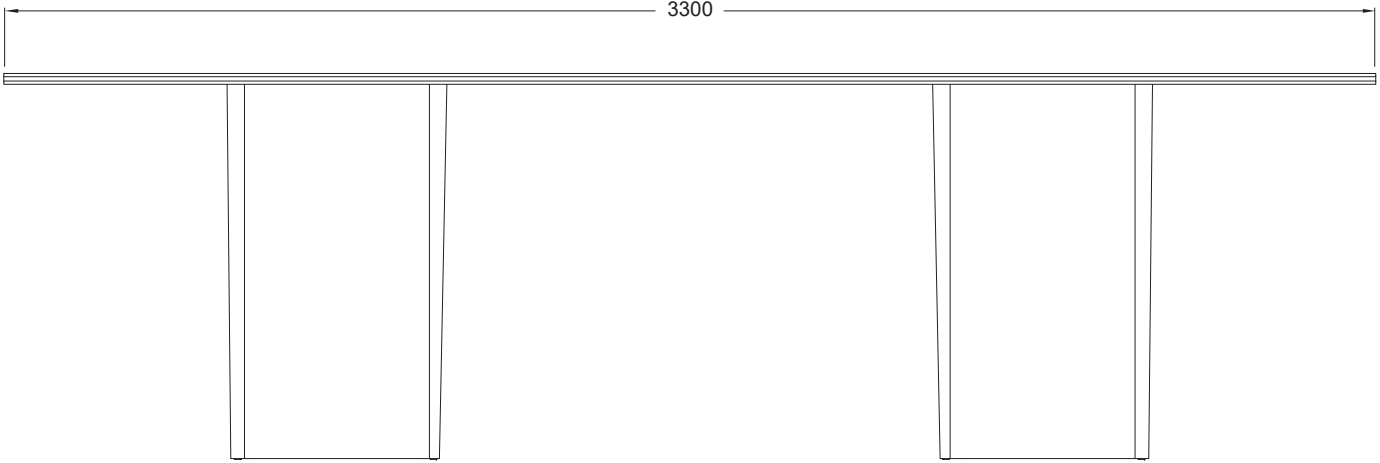

# CREVASSE BAR TABLE RANGE

CV-BTB[90].360x100

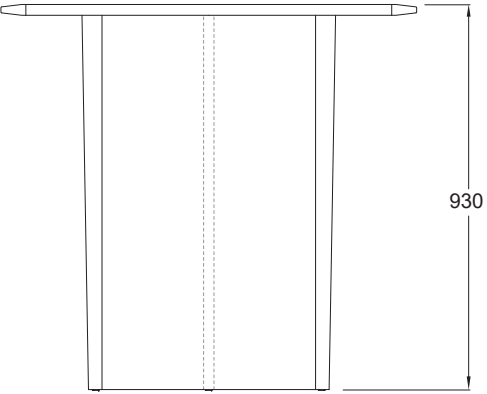
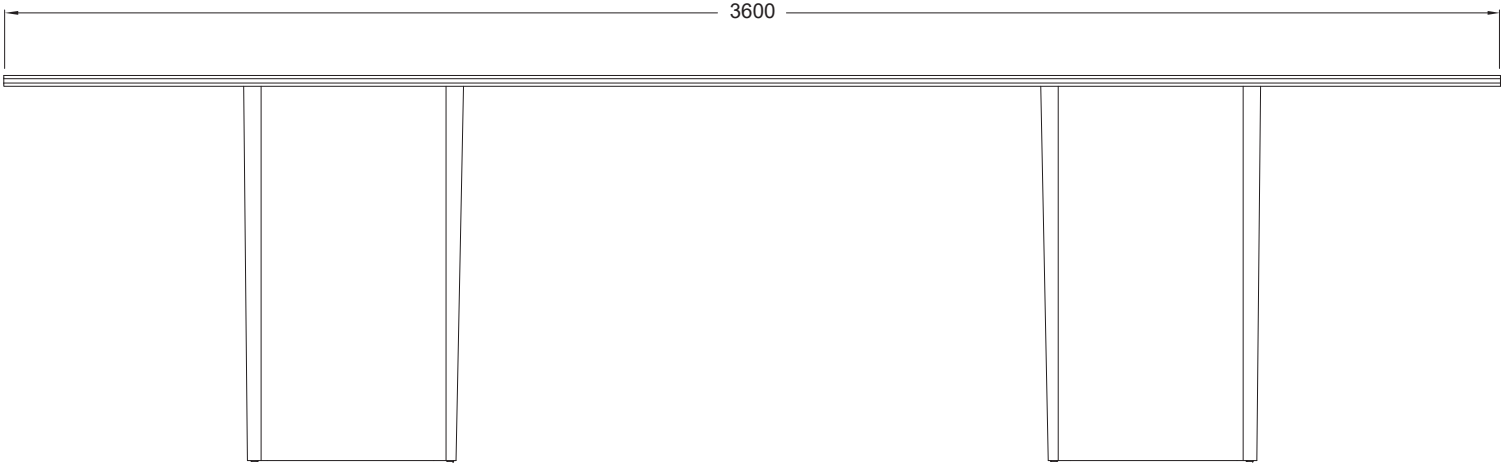
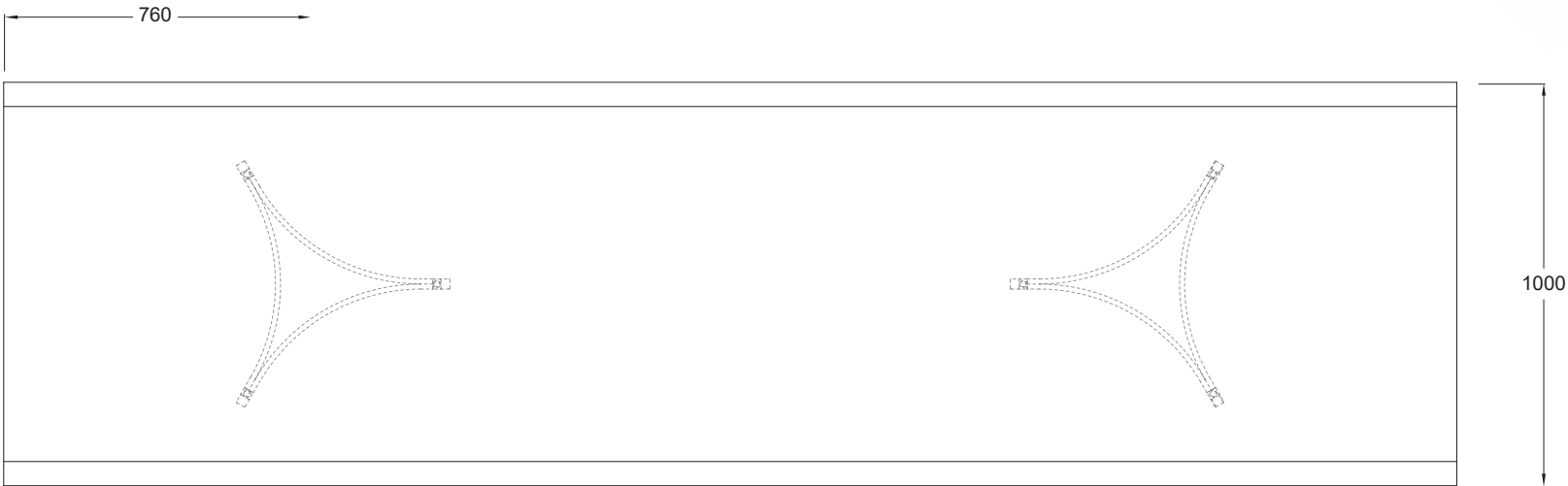

# CREVASSE BAR TABLE RANGE

CV-BTB[90].180x130

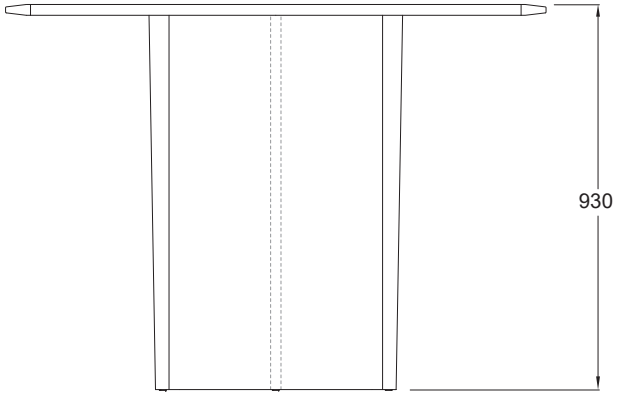
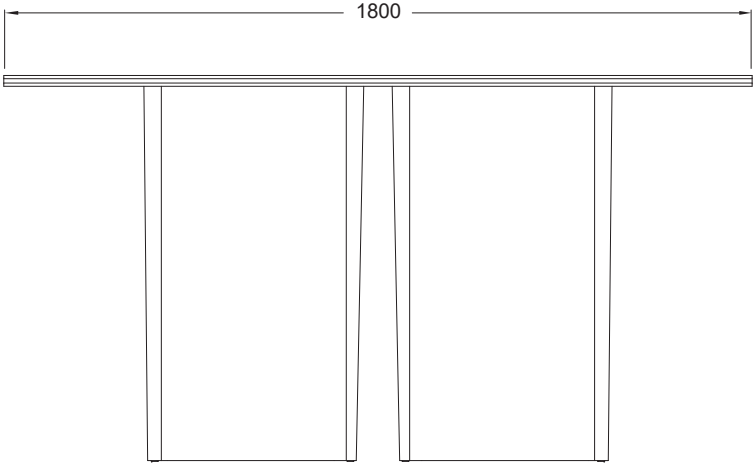
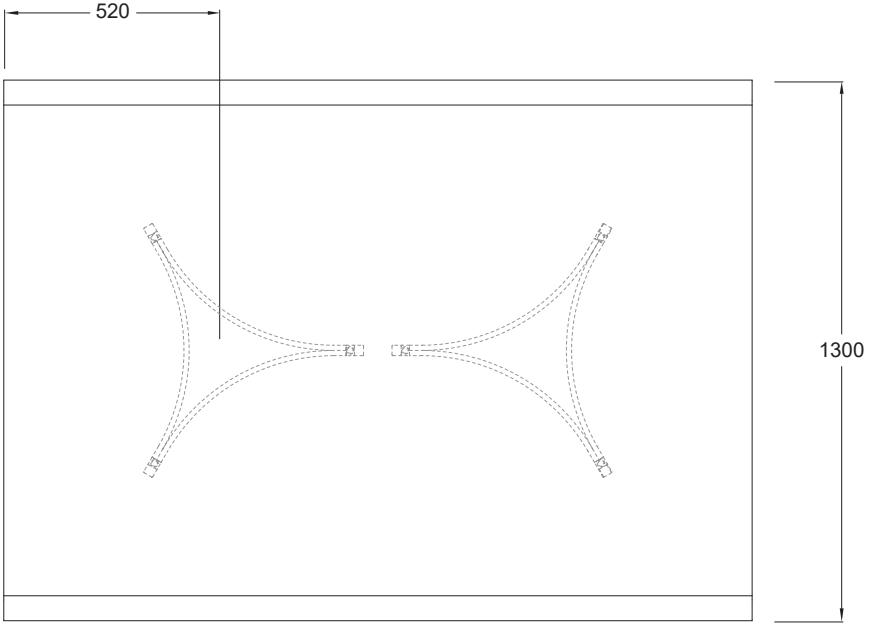

# CREVASSE BAR TABLE RANGE

CV-BTB[90].210x130

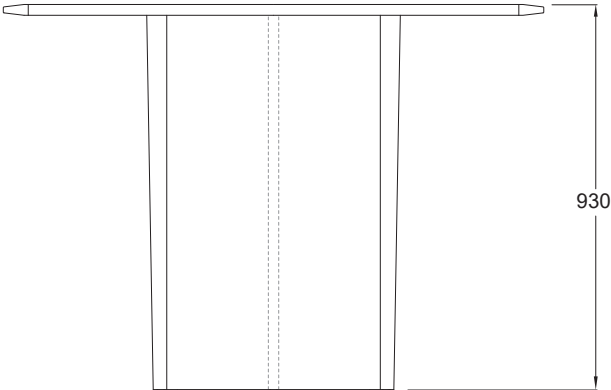
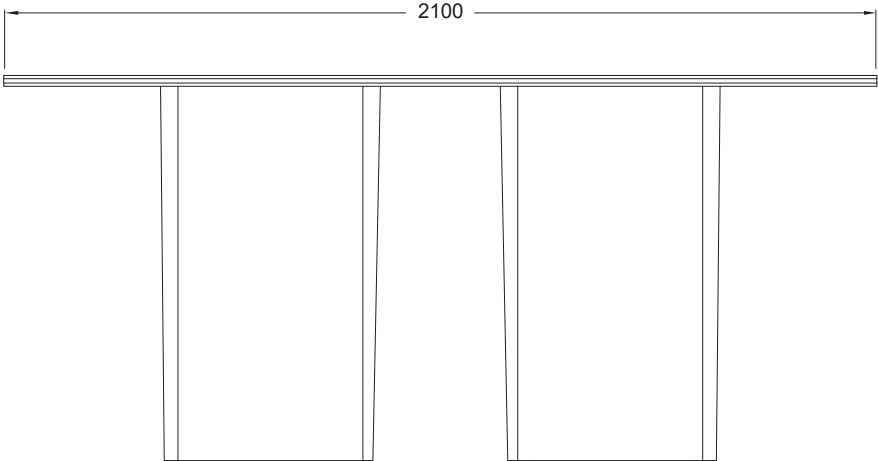
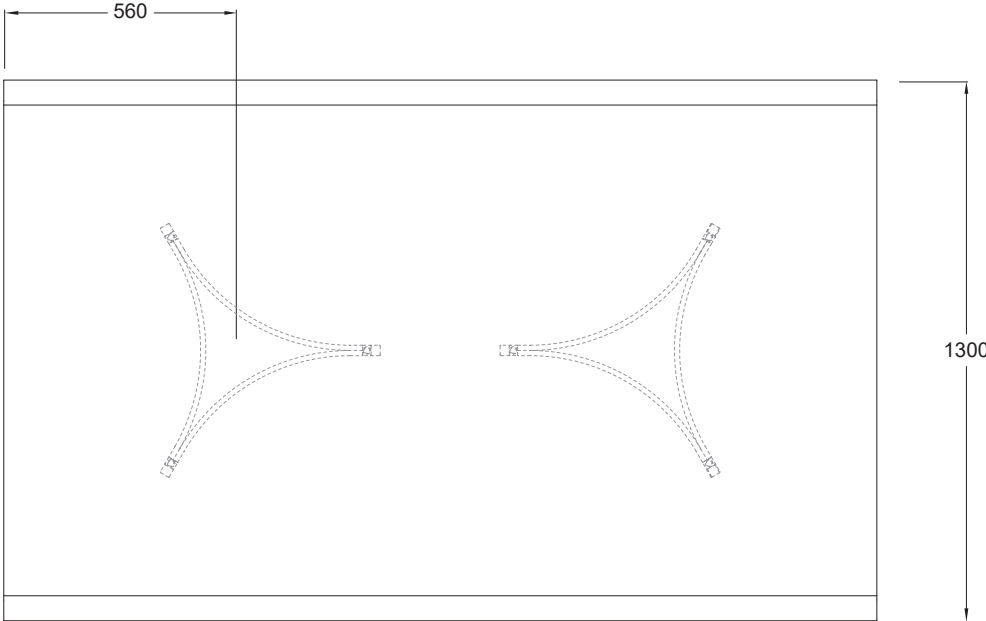

# CREVASSE BAR TABLE RANGE

CV-BTB[90].240x130

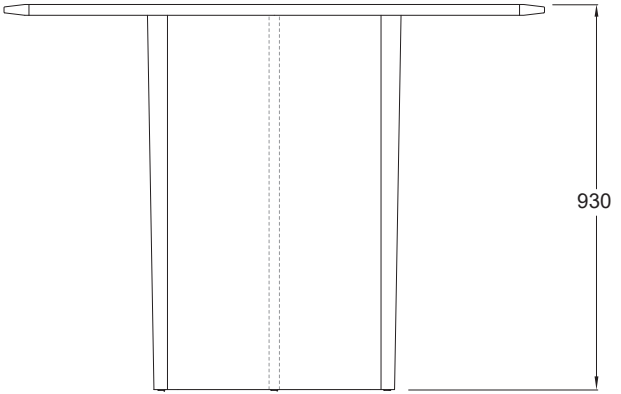
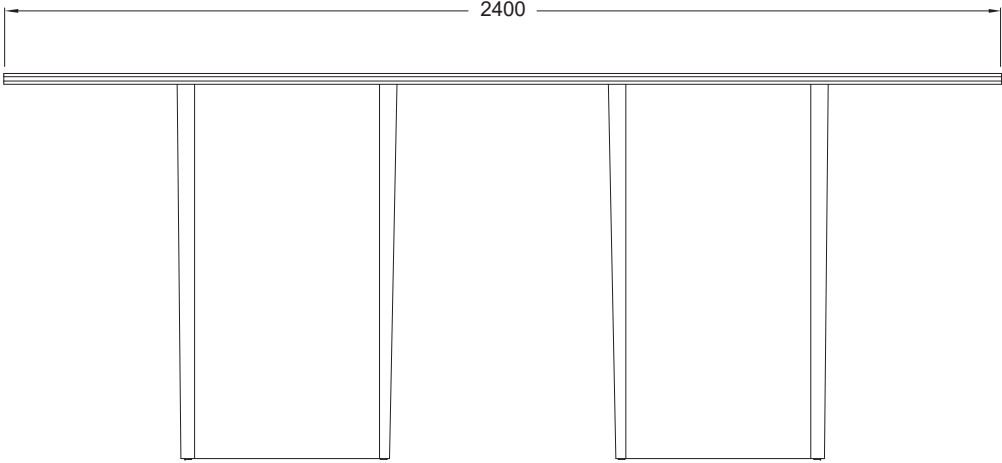
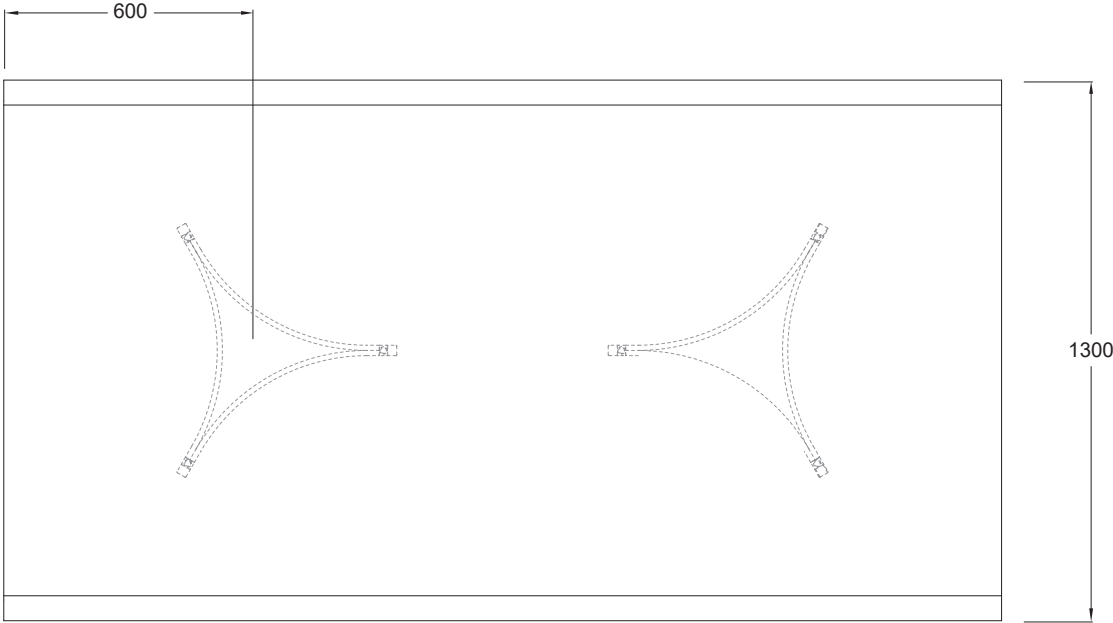

# CREVASSE BAR TABLE RANGE

CV-BTB[90].270x130

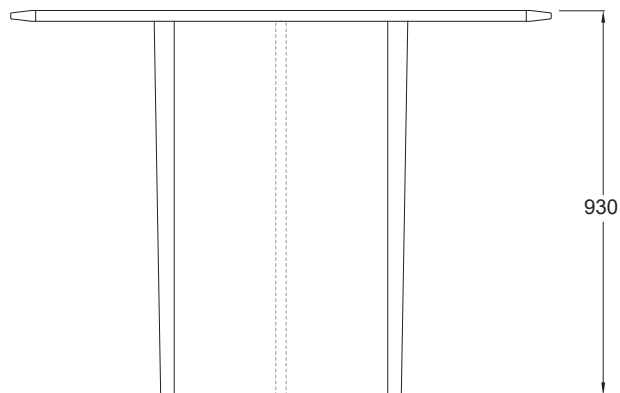
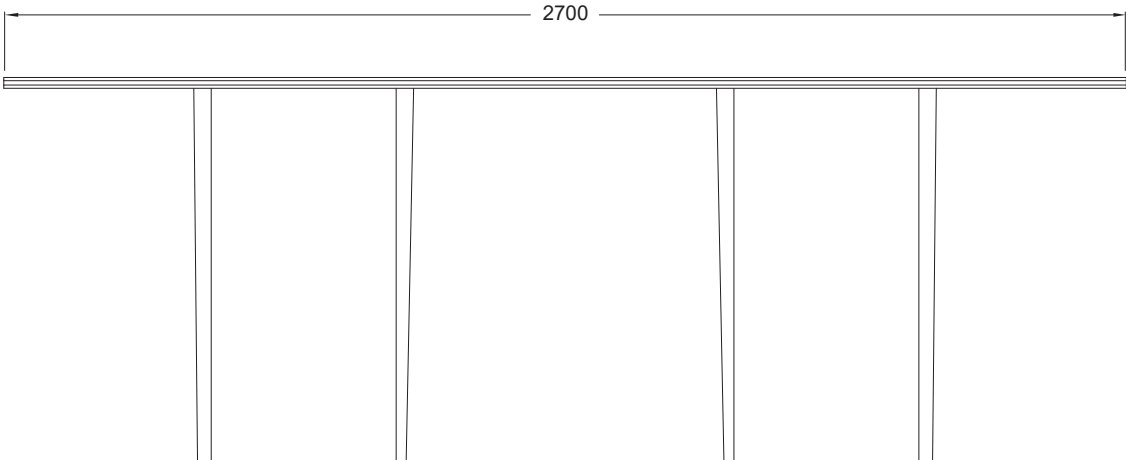
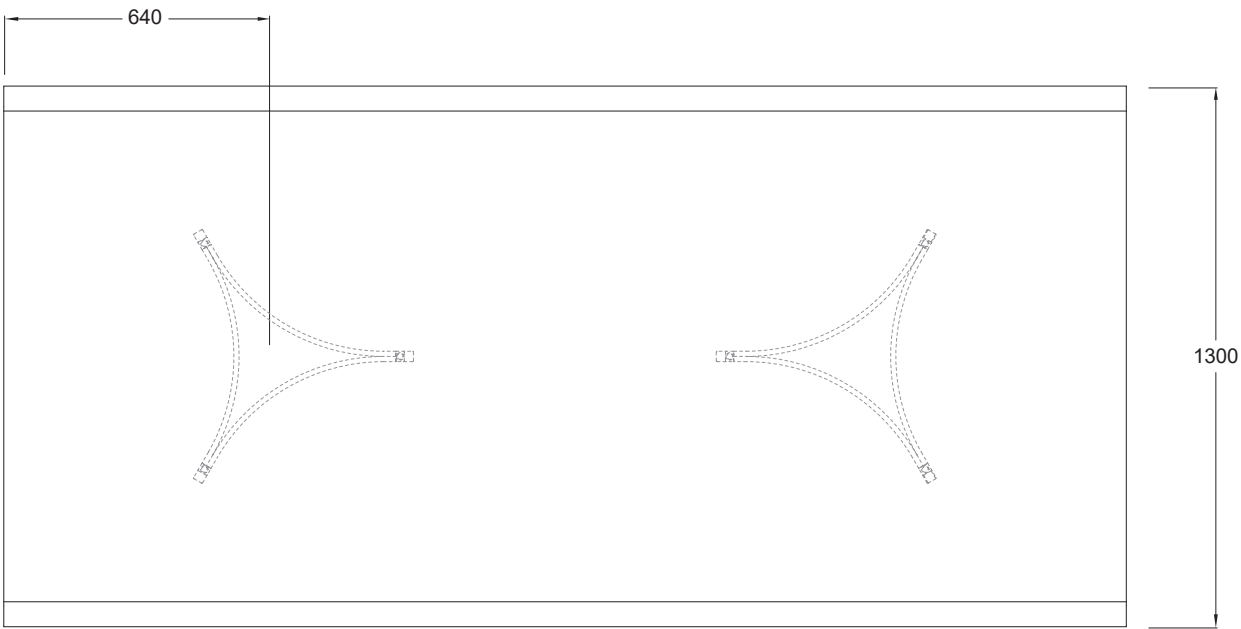

# CREVASSE BAR TABLE RANGE

CV-BTB[90].300x130

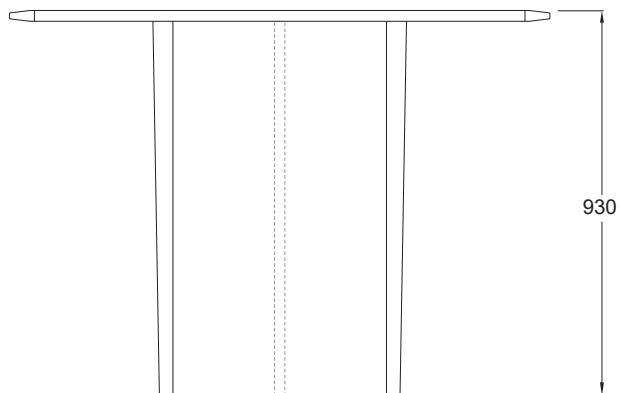
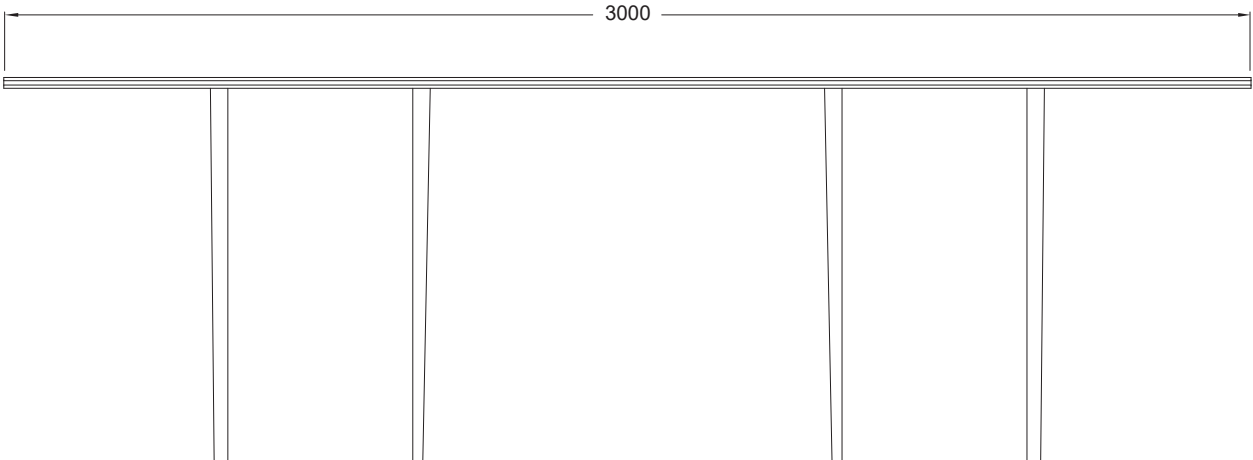
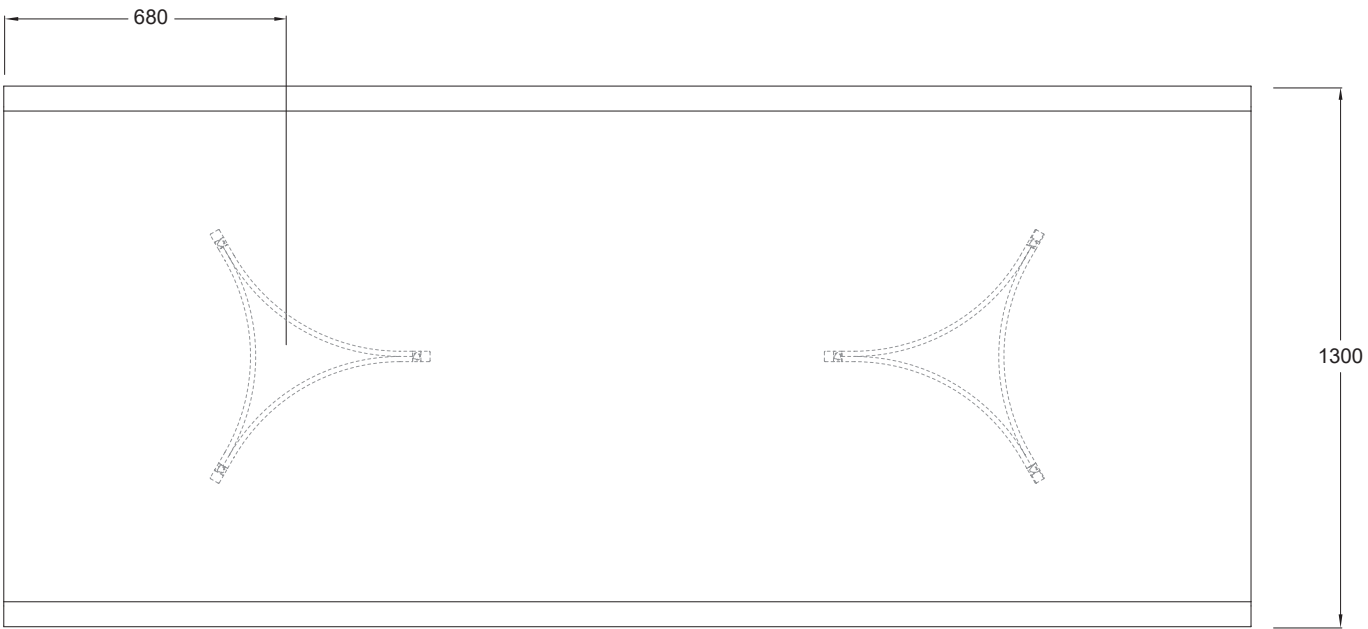



# CREVASSE BAR TABLE RANGE

CV-BTB[90].330x130

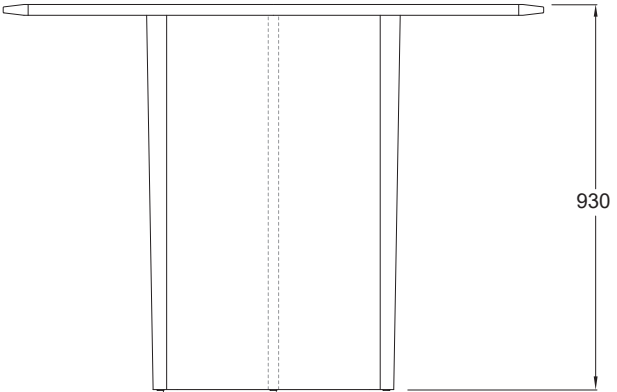
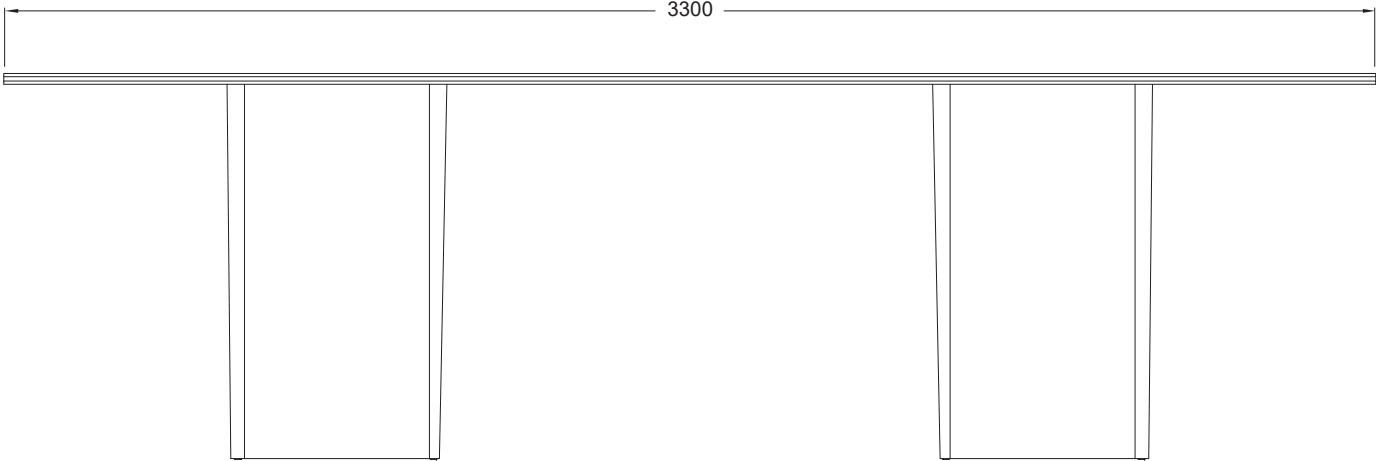
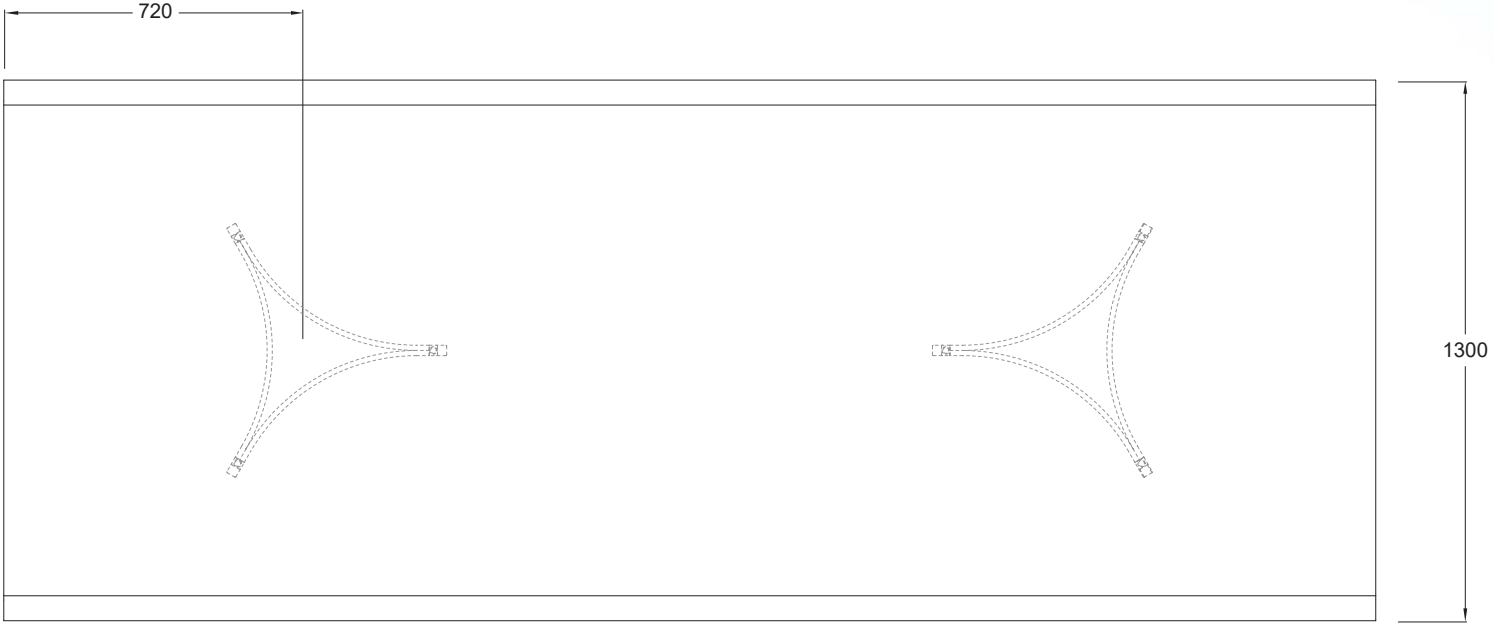

# CREVASSE BAR TABLE RANGE

CV-BTB[90].360x130

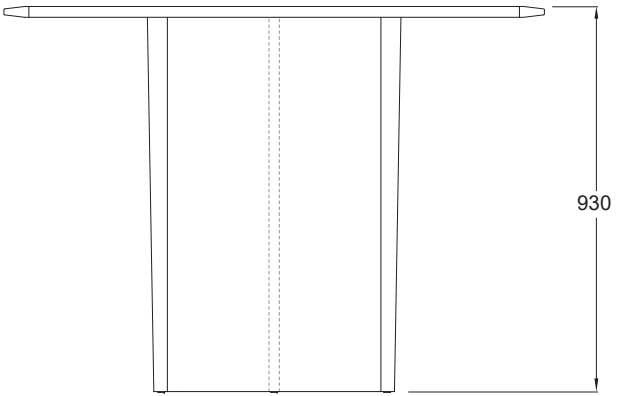
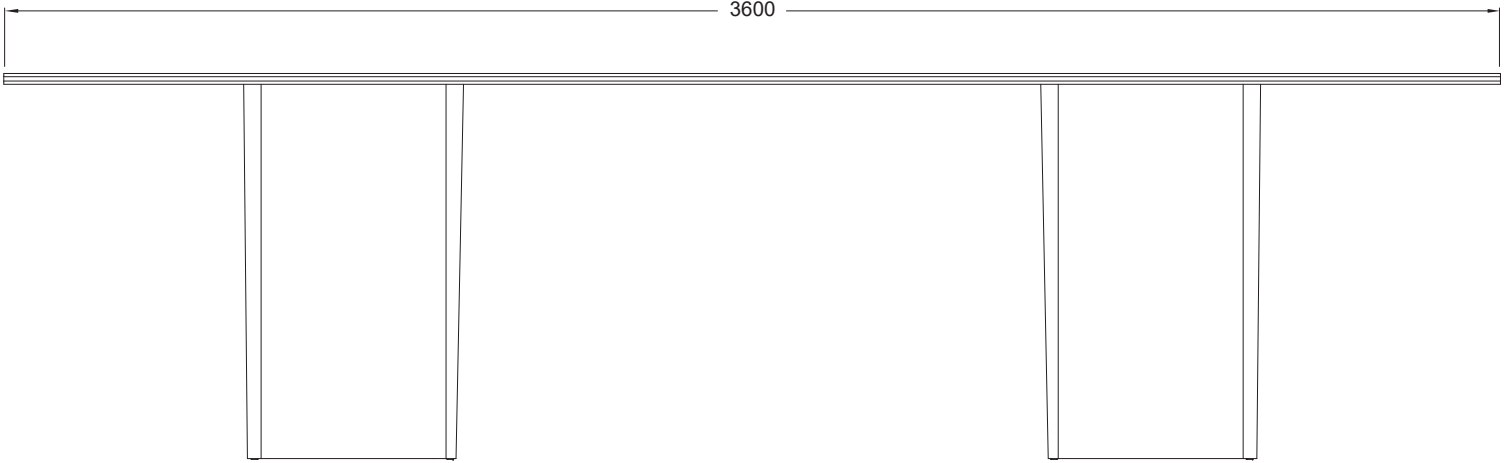
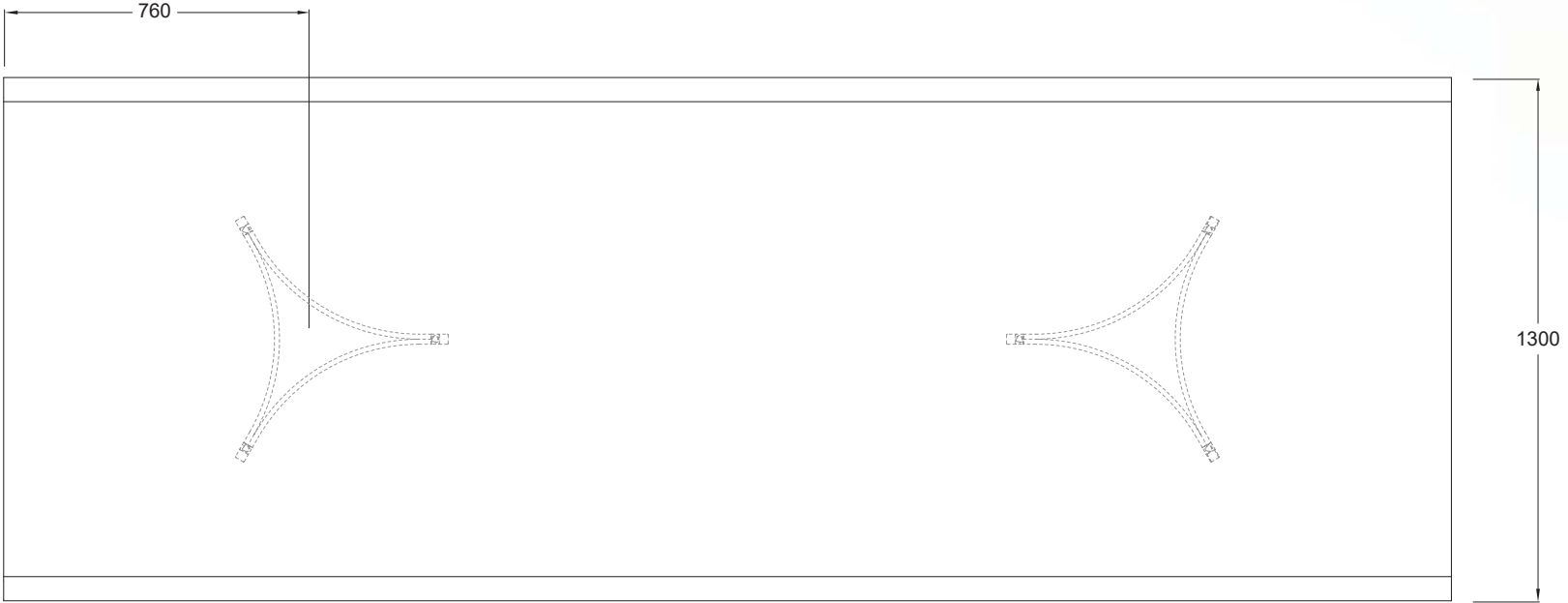

# CREVASSE BAR TABLE RANGE

CV-BTB[90].300x150

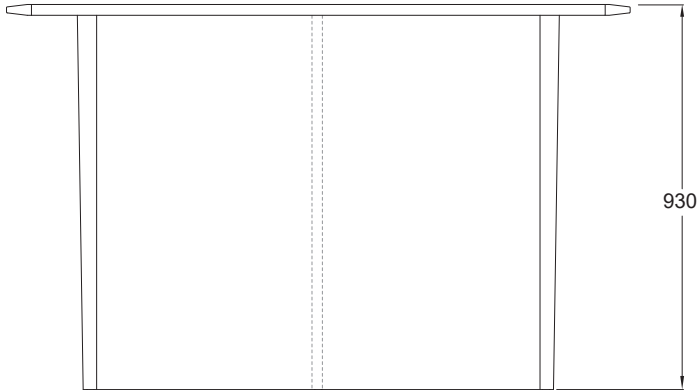
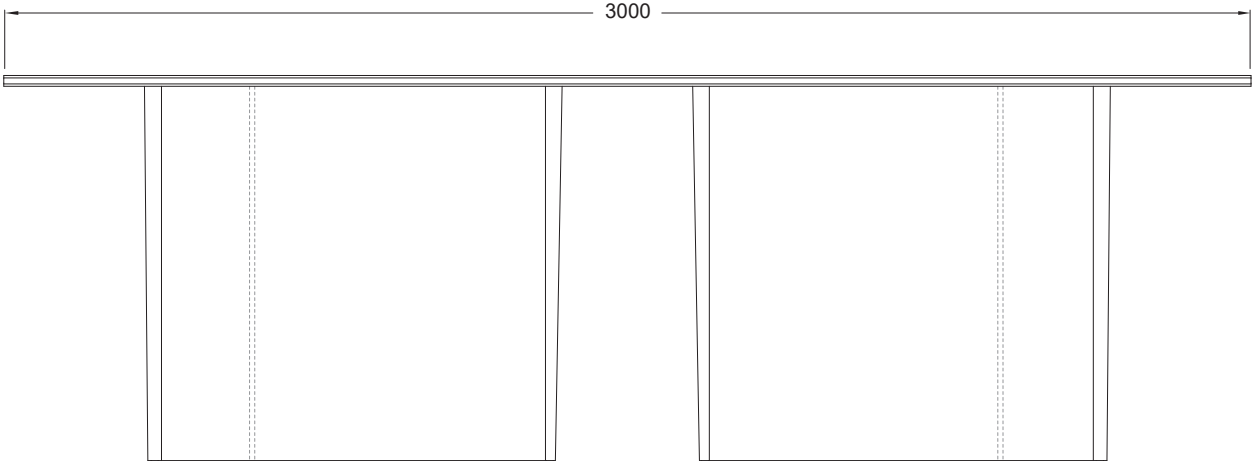
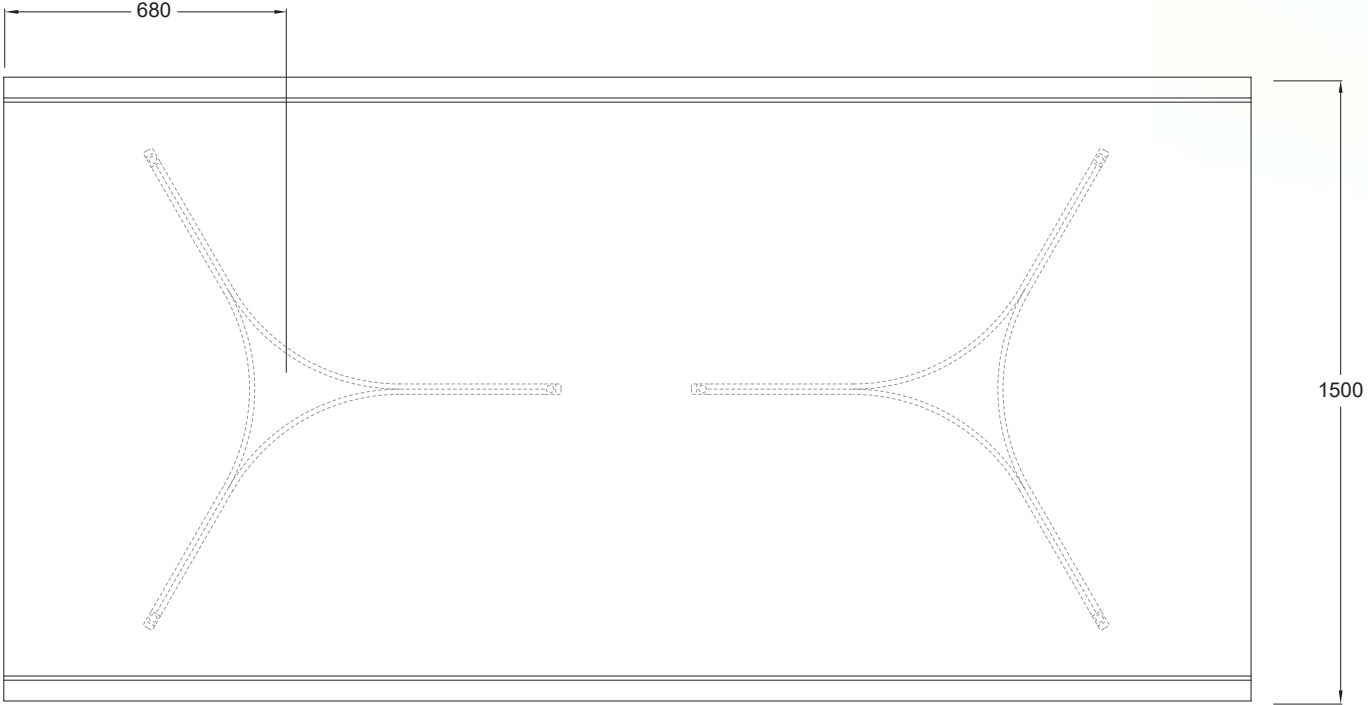
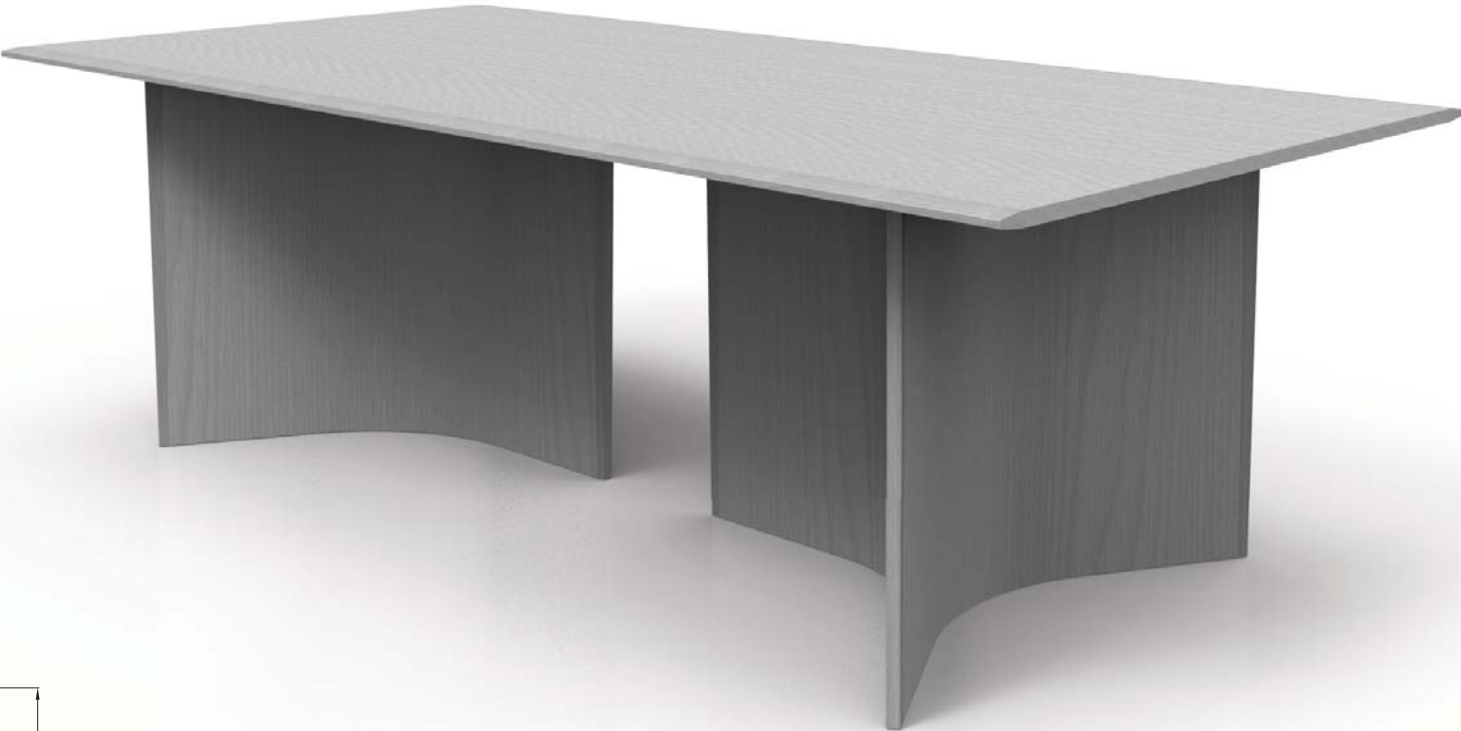

# CREVASSE BAR TABLE RANGE

CV-BTB[90].330x150

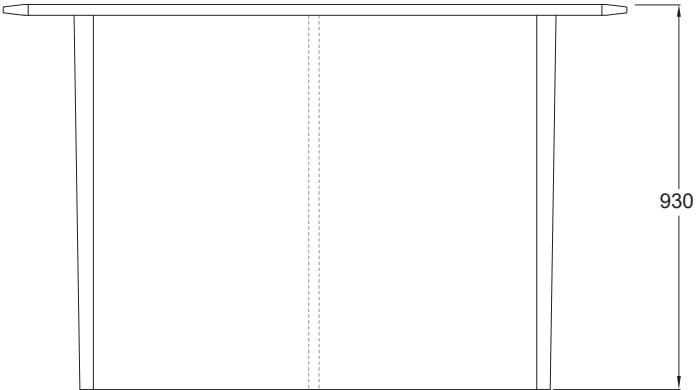
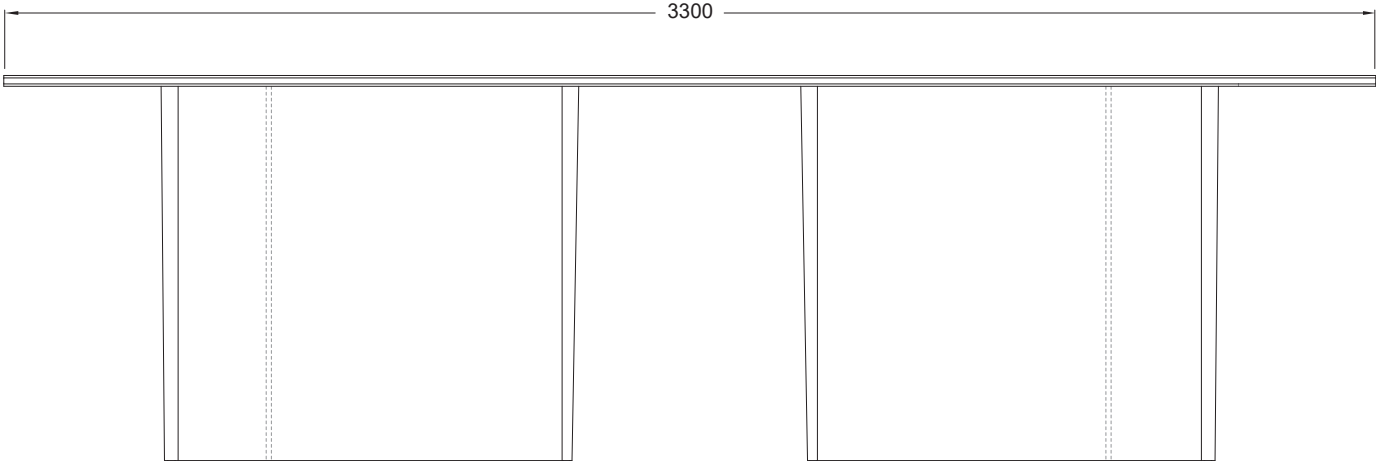
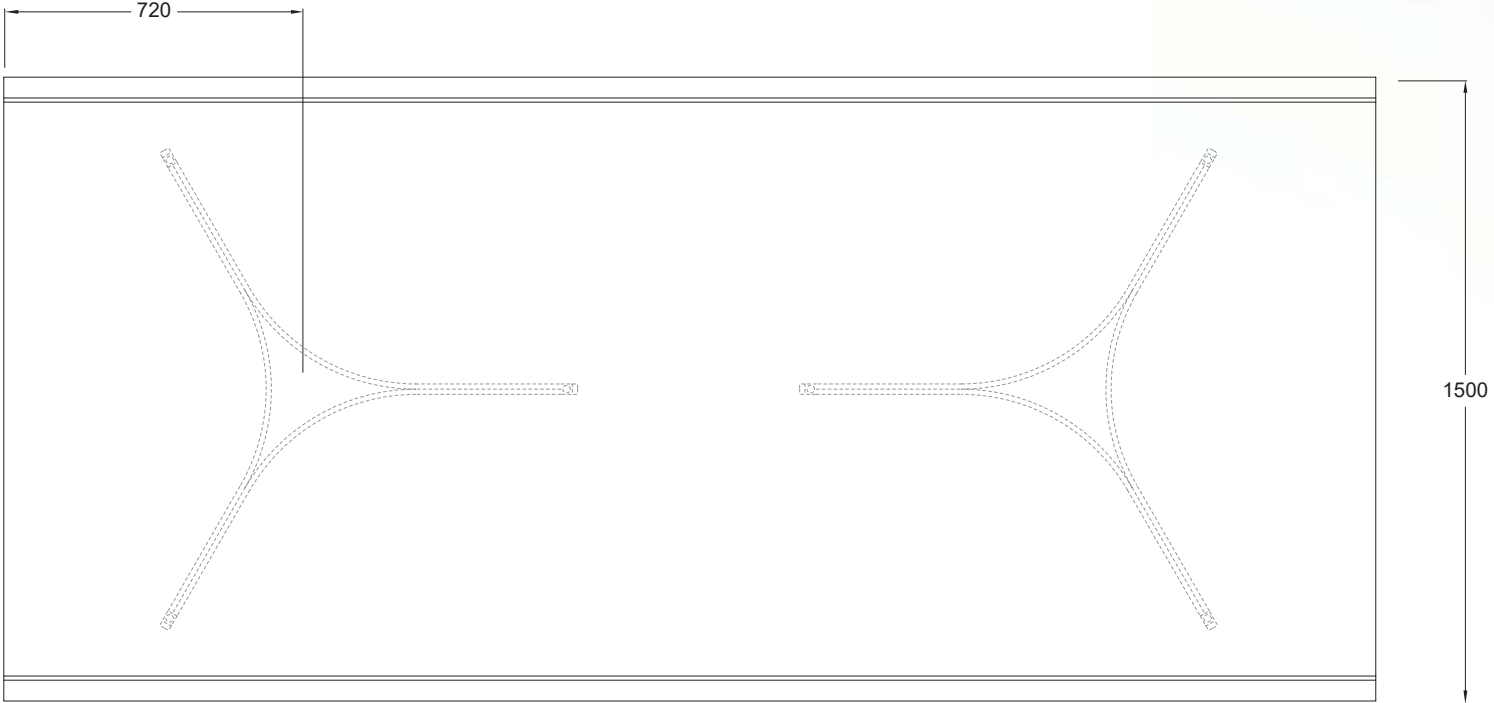
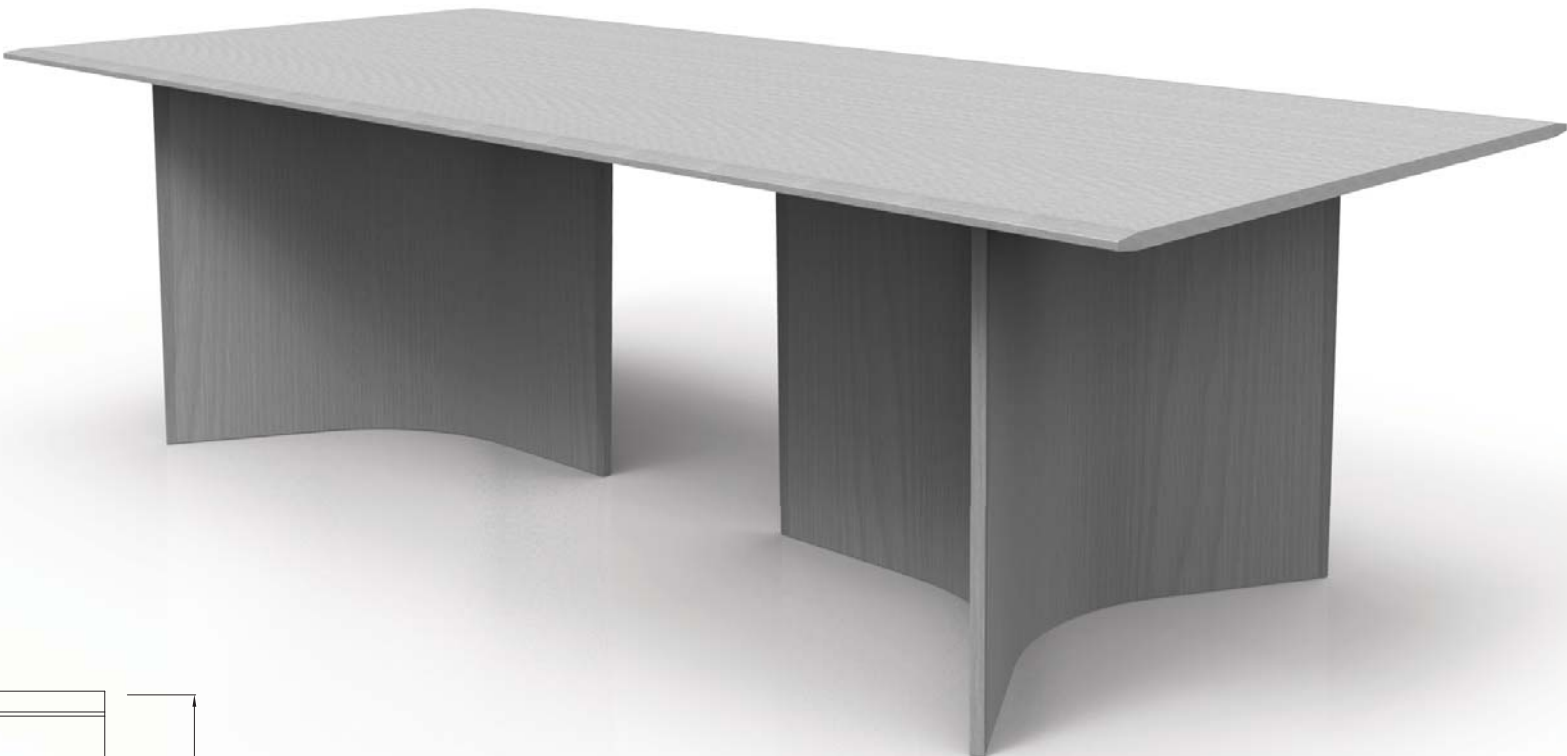

# CREVASSE BAR TABLE RANGE

CV-BTB[90].360x150

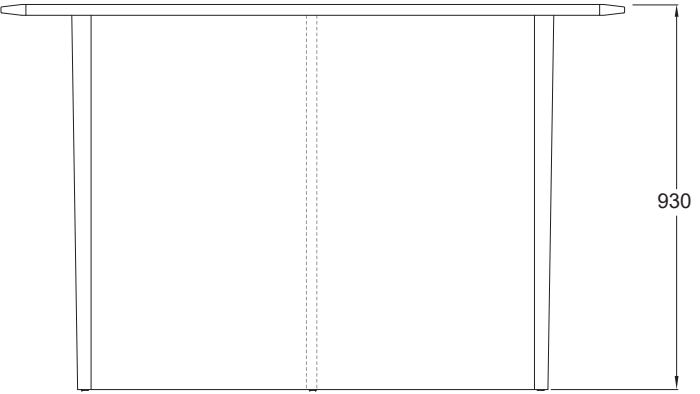
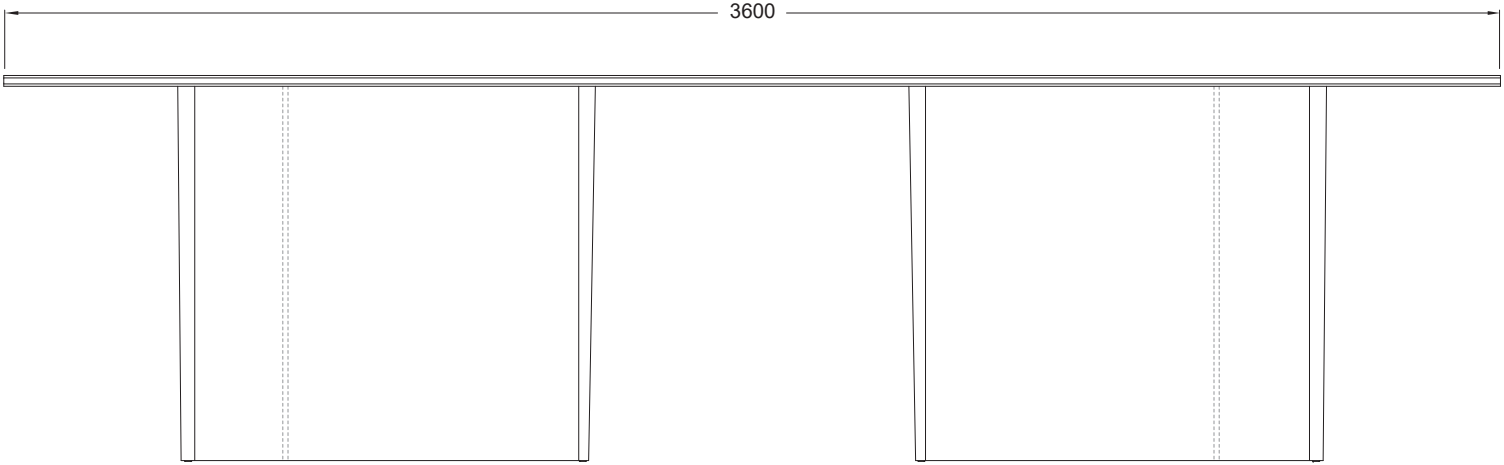
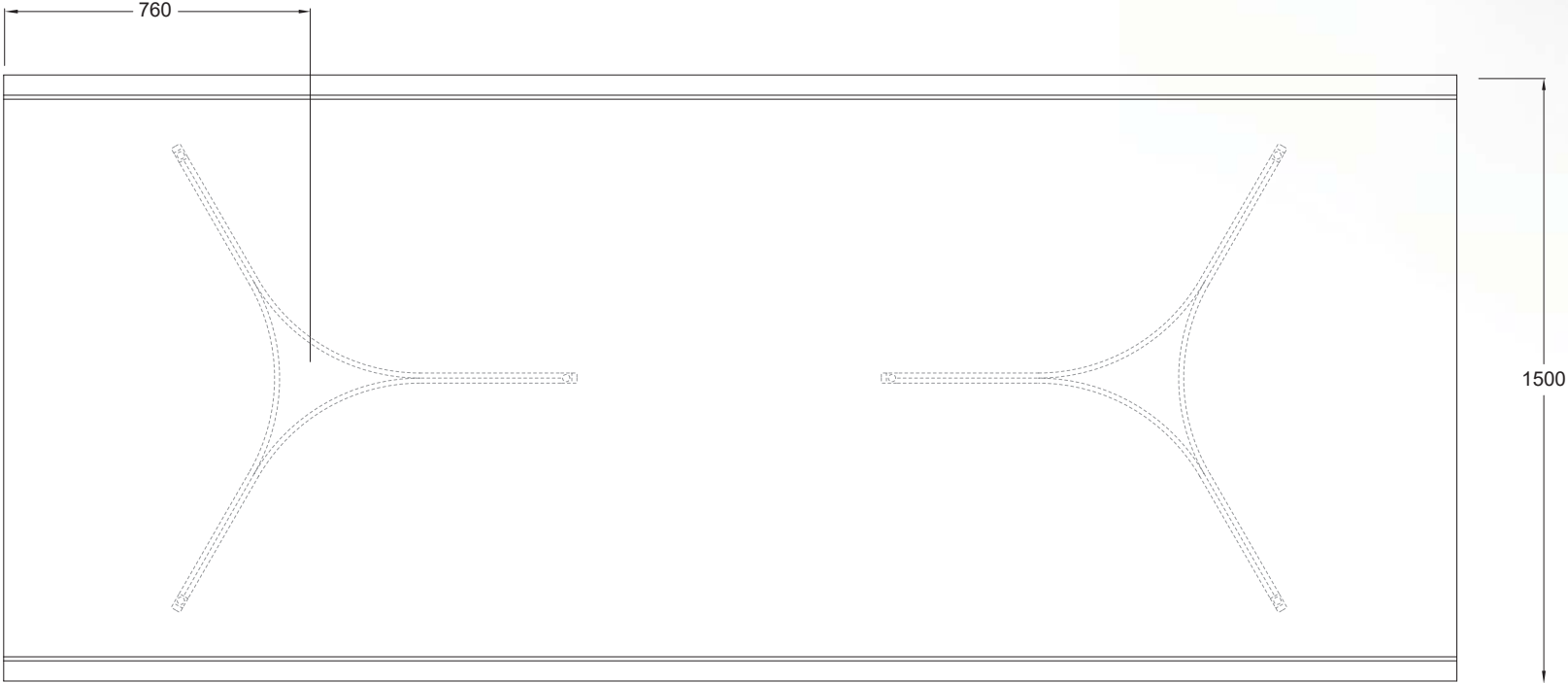

# CREVASSE BAR TABLE RANGE

CV-BTB[90].300x180

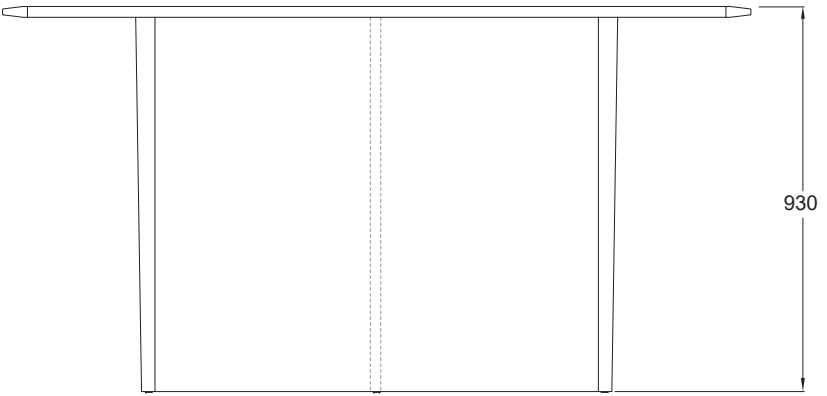
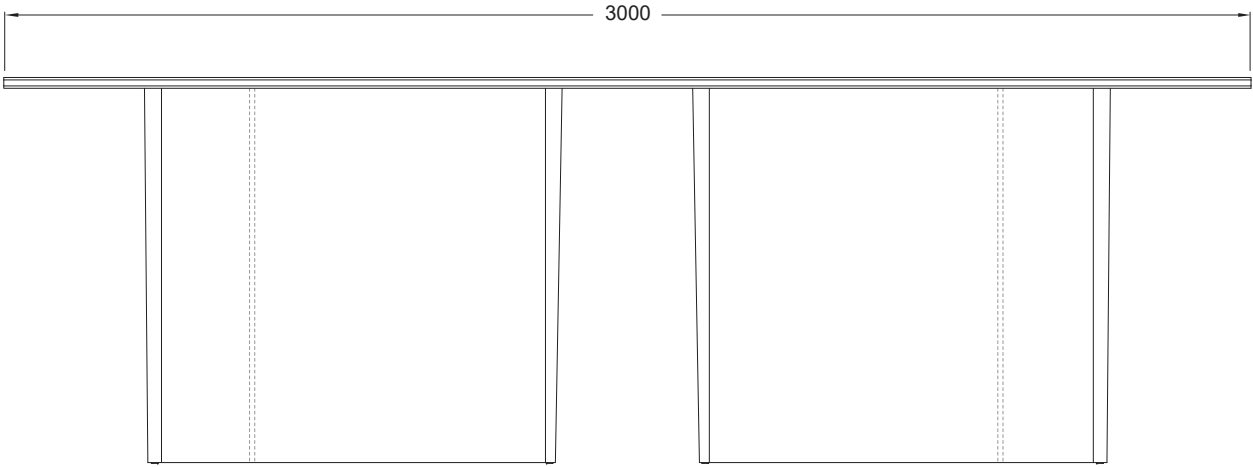
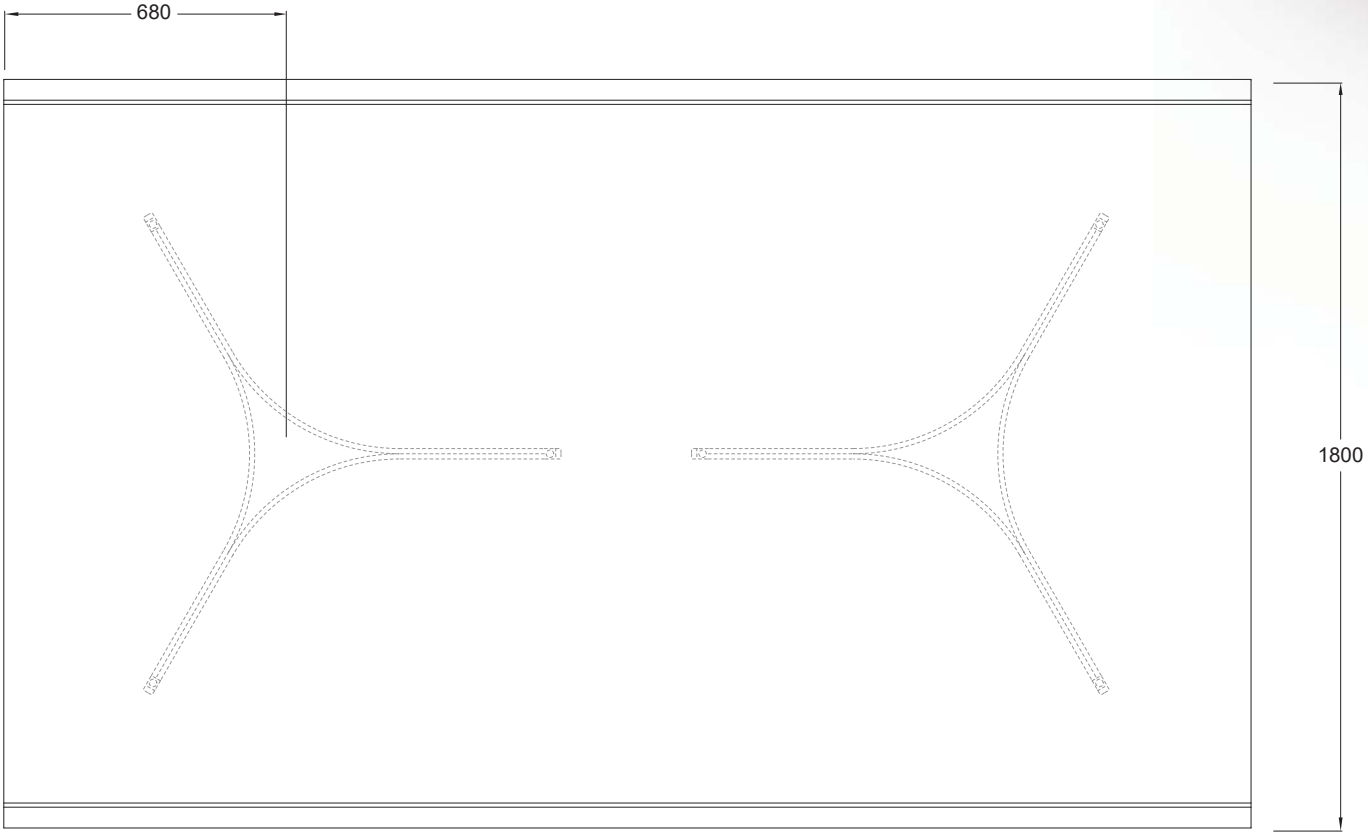
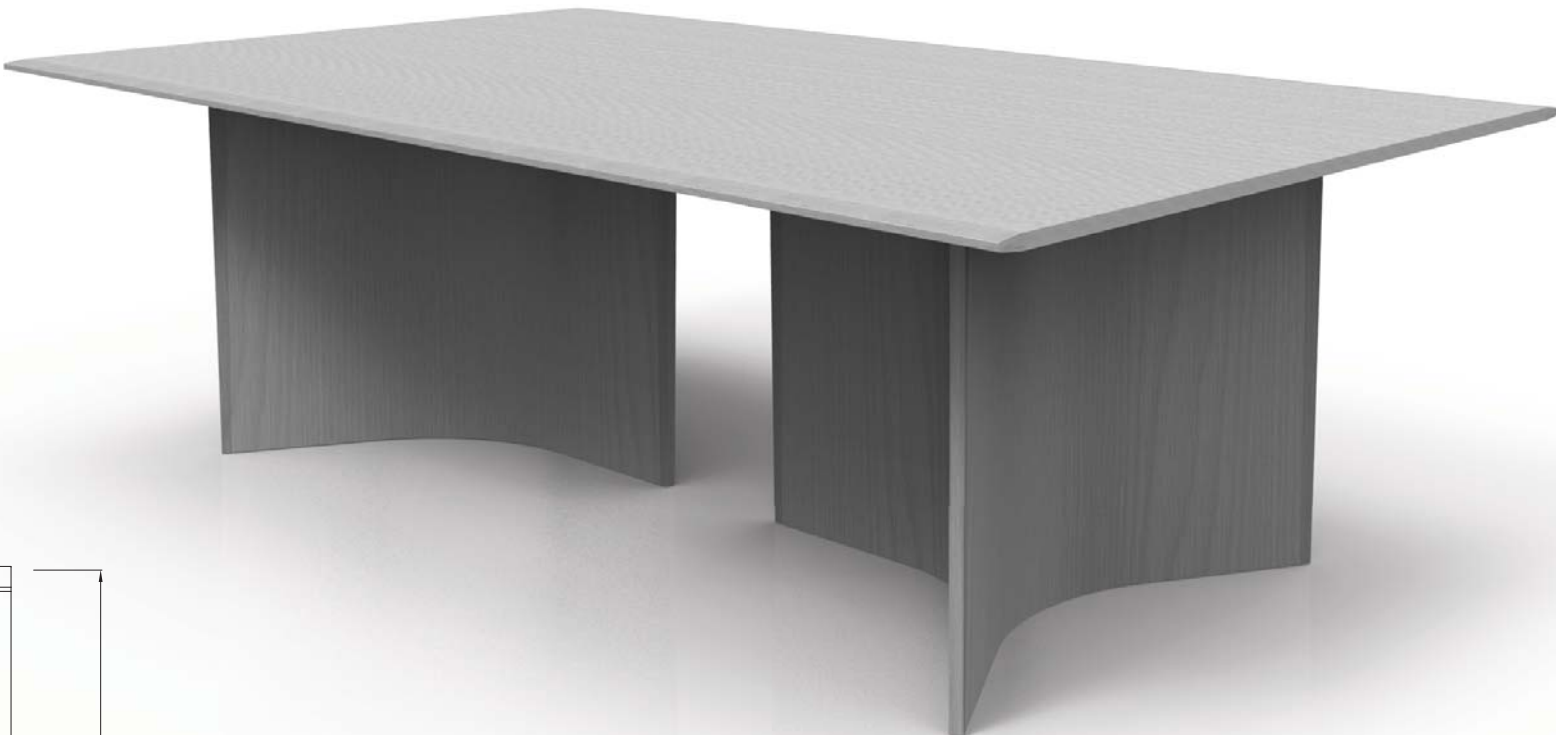

# CREVASSE BAR TABLE RANGE

CV-BTB[90].330x180

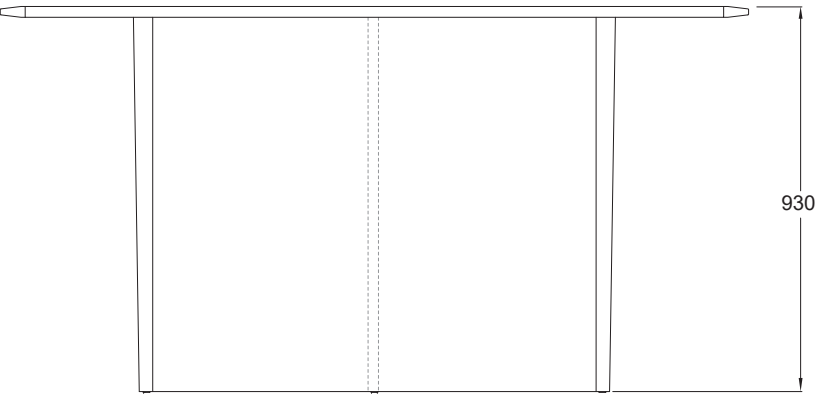
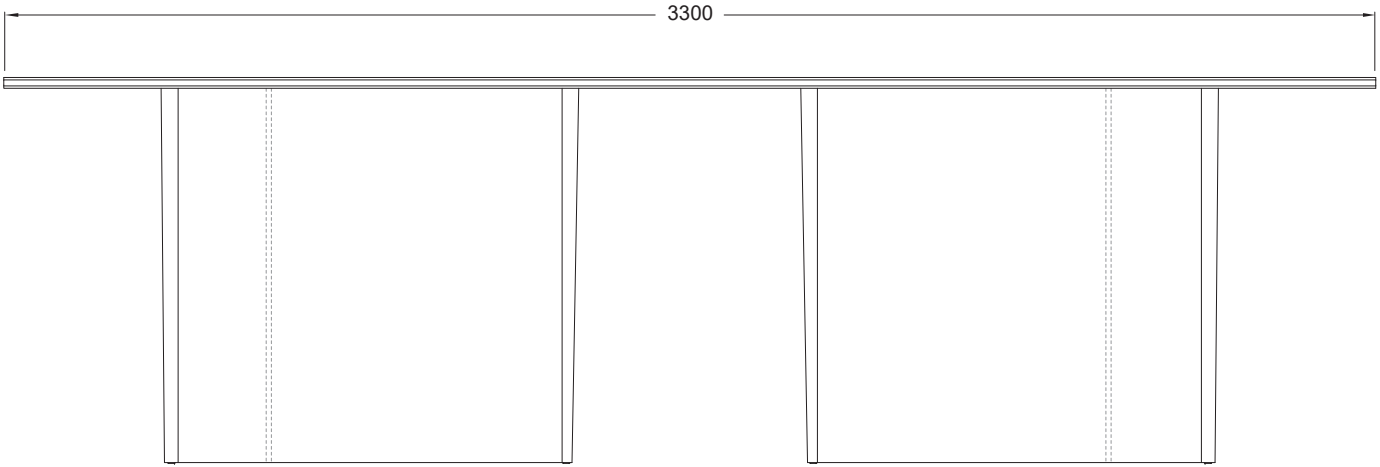
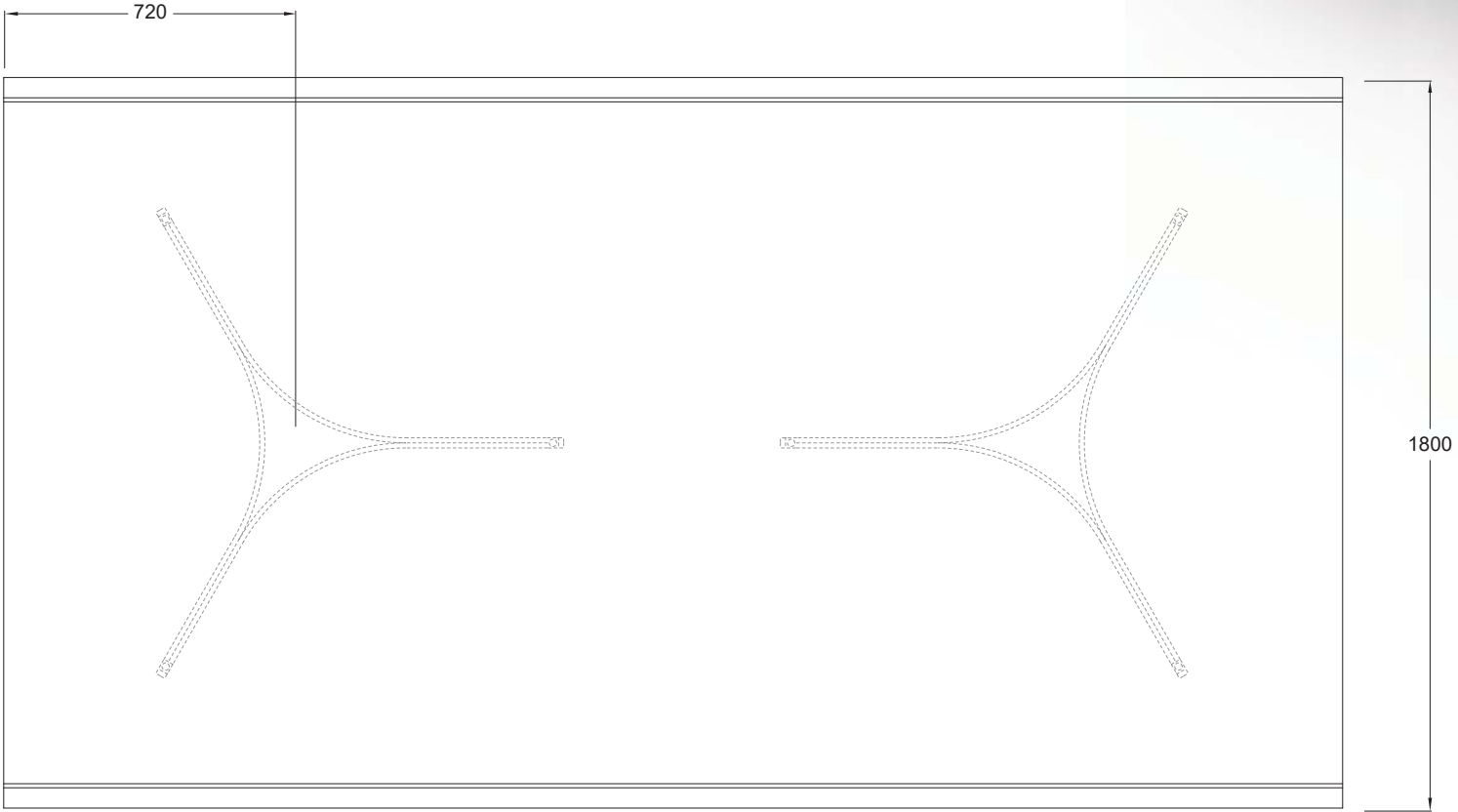
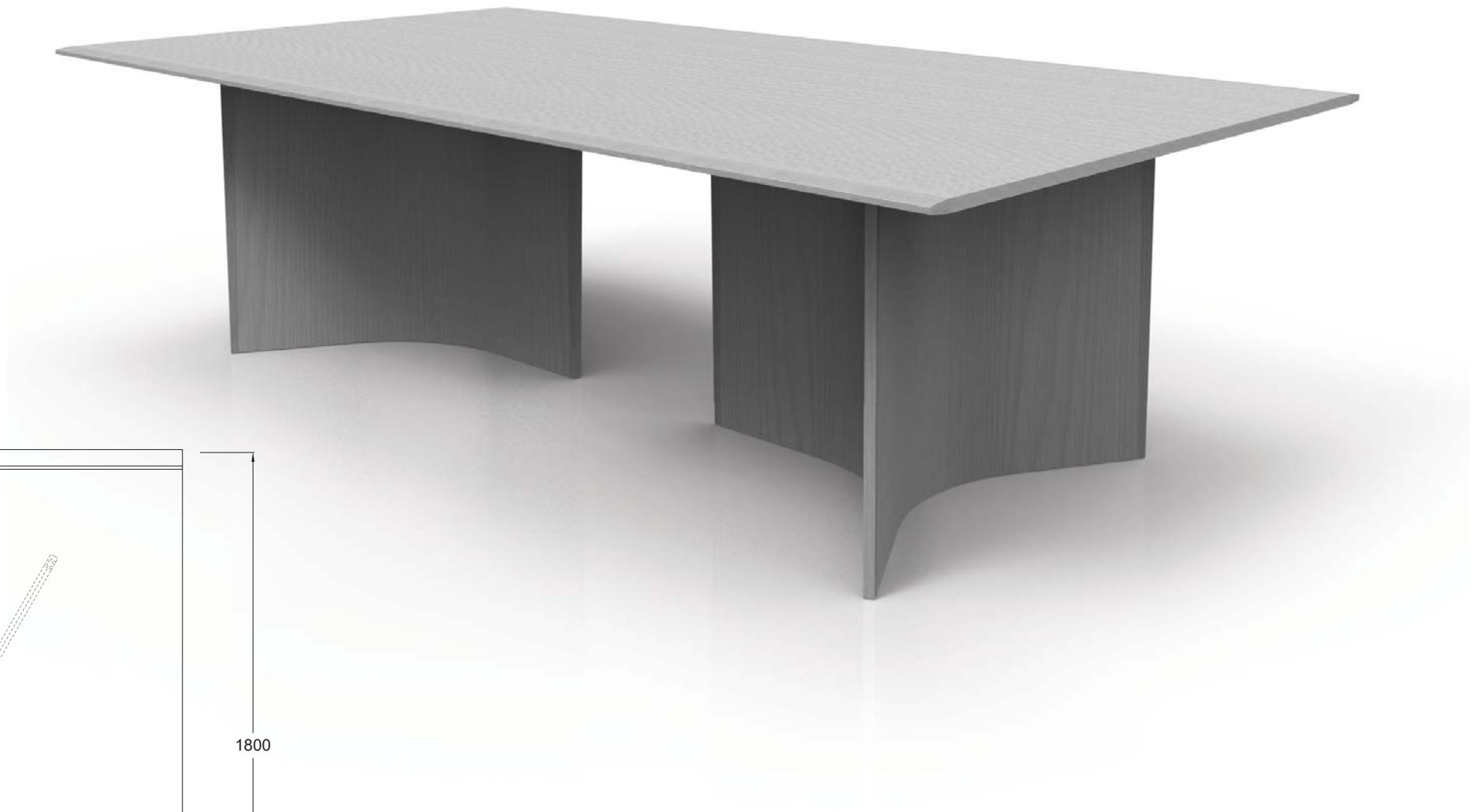

# CREVASSE BAR TABLE RANGE

CV-BTB[90].360x180

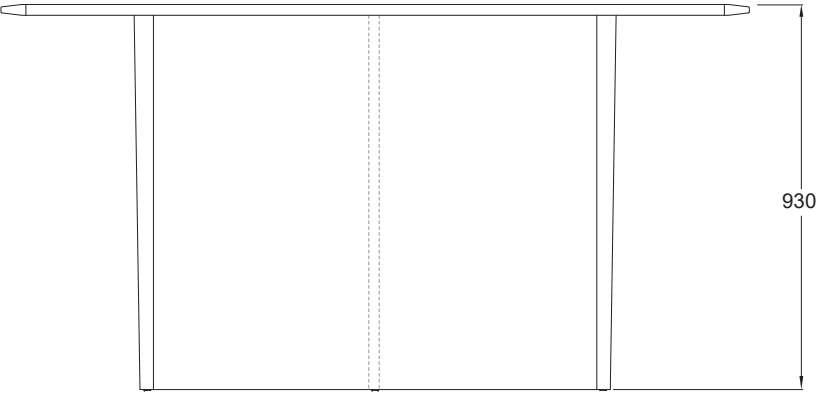
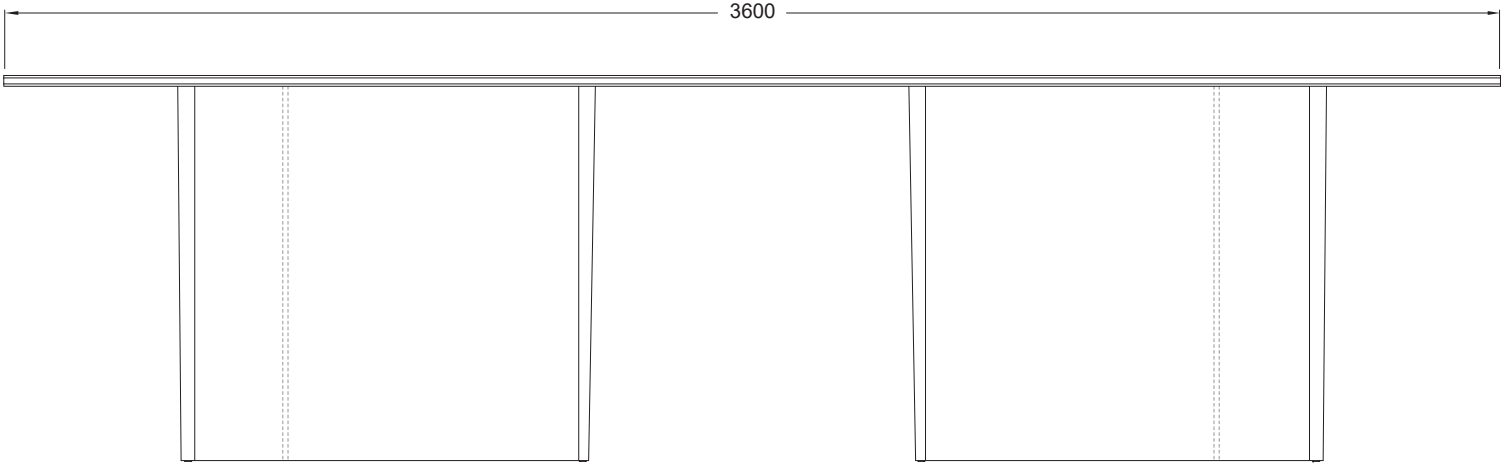
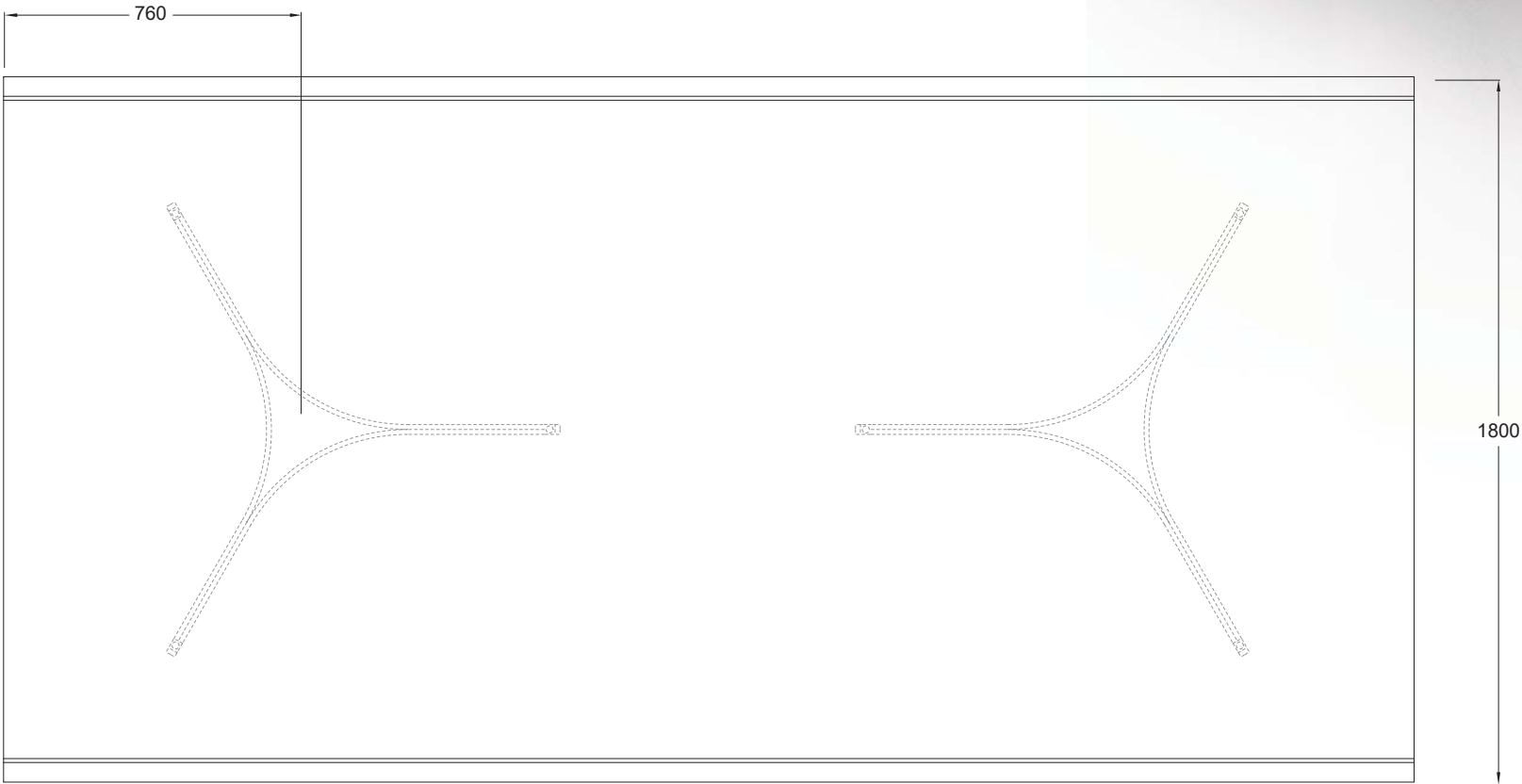
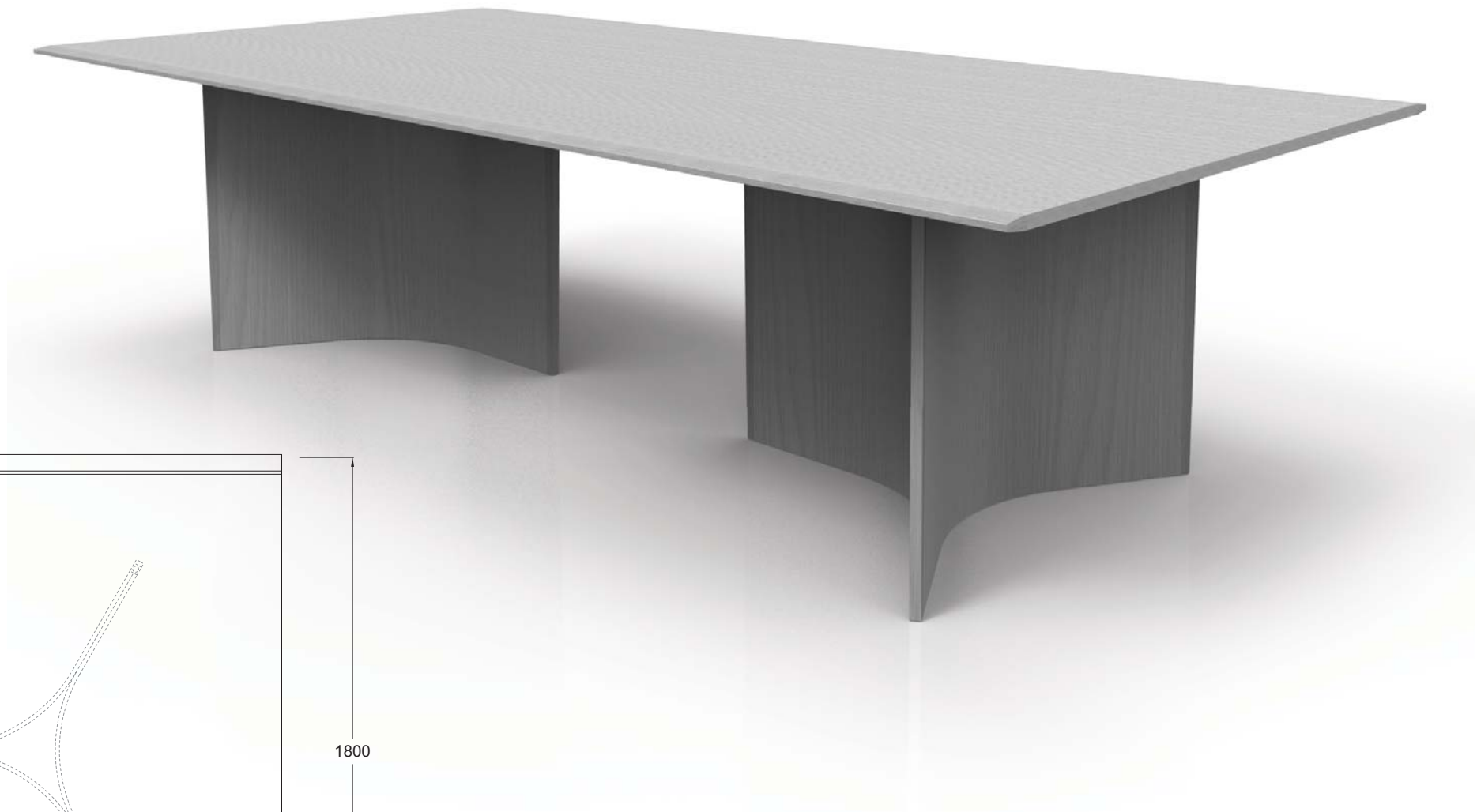



# CREVASSE BAR TABLE RANGE

CV-BTB[103].180x100

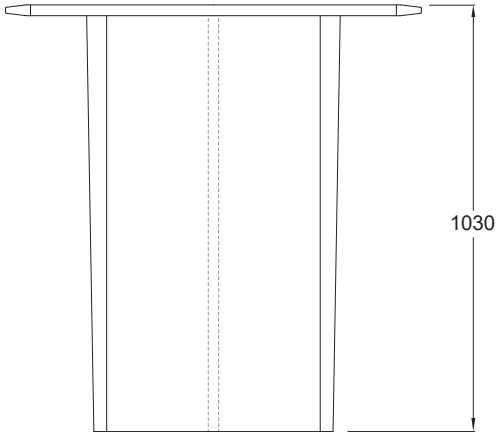
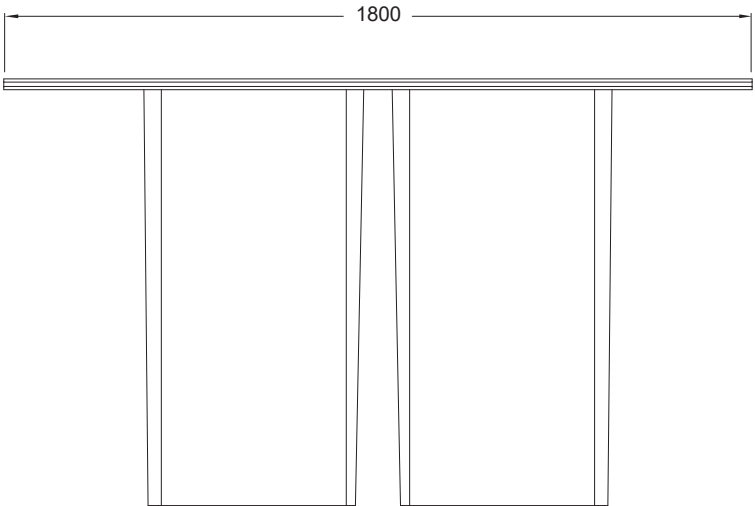
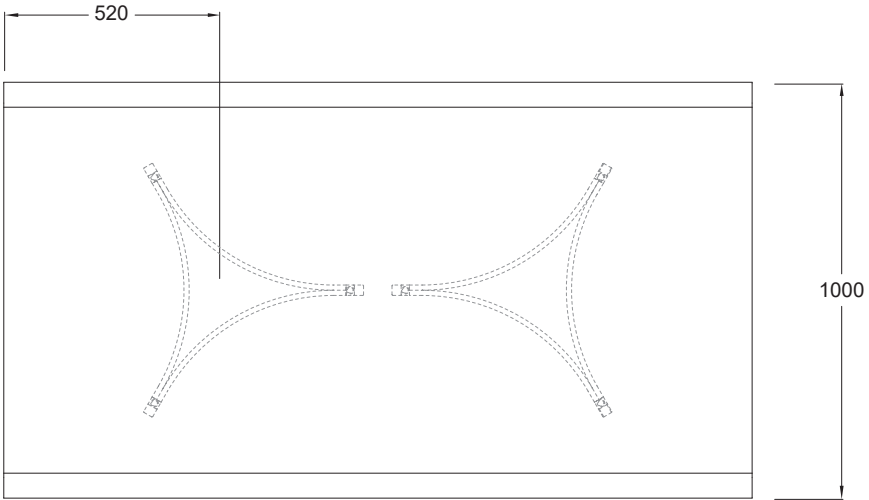

# CREVASSE BAR TABLE RANGE

CV-BTB[103].210x100

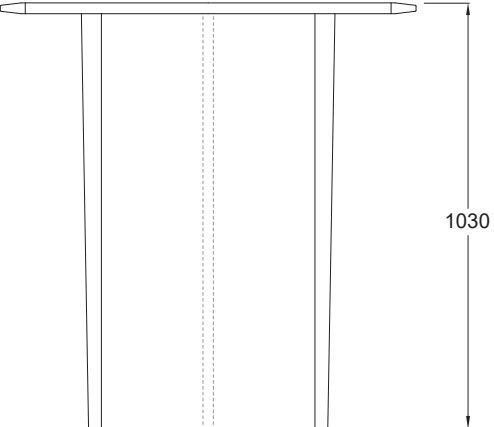
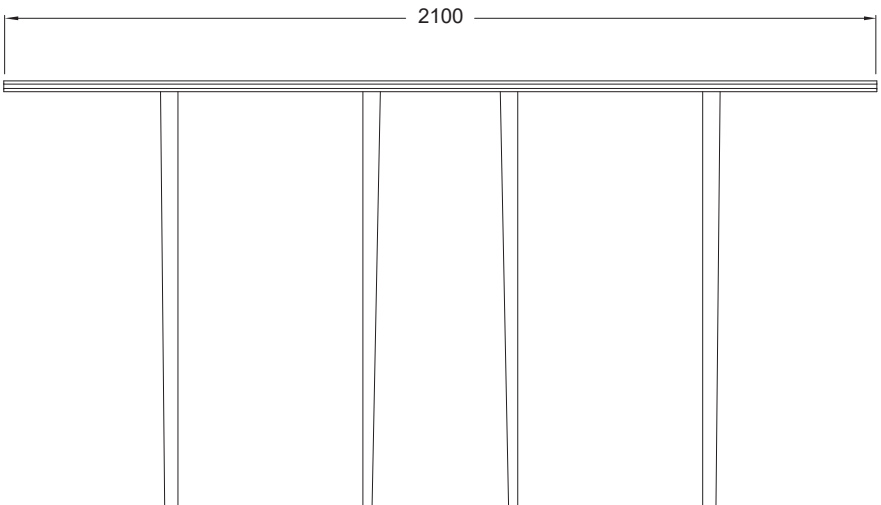
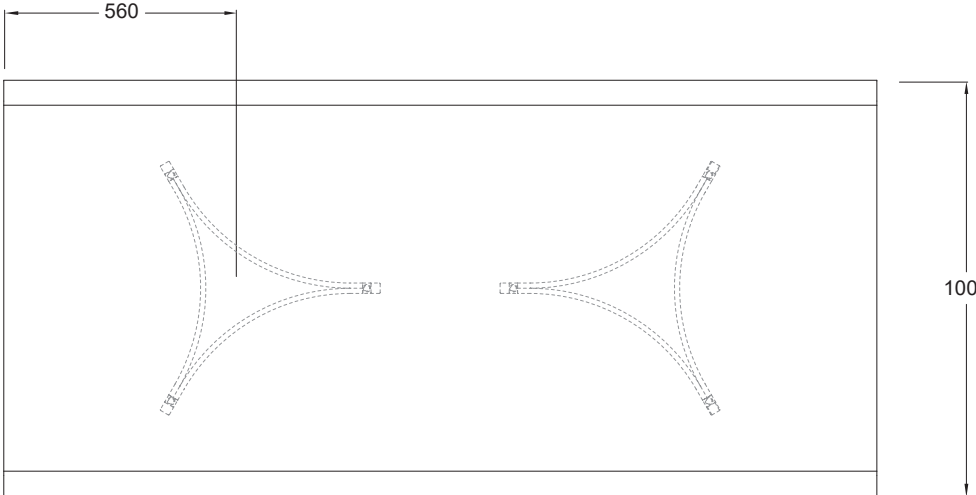

# CREVASSE BAR TABLE RANGE

CV-BTB[103].240x100

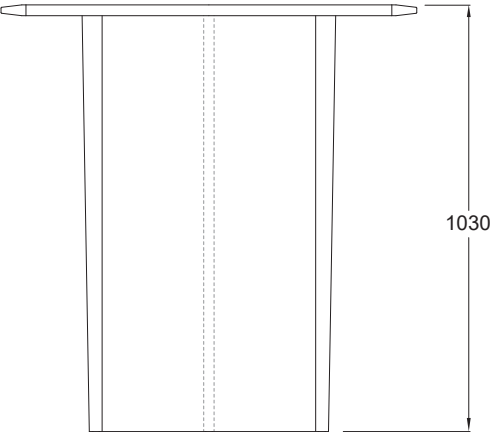
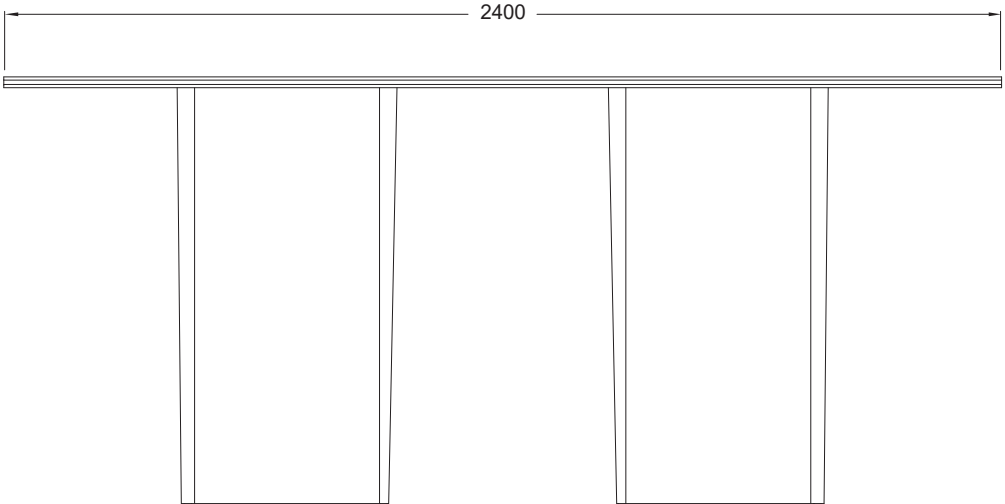
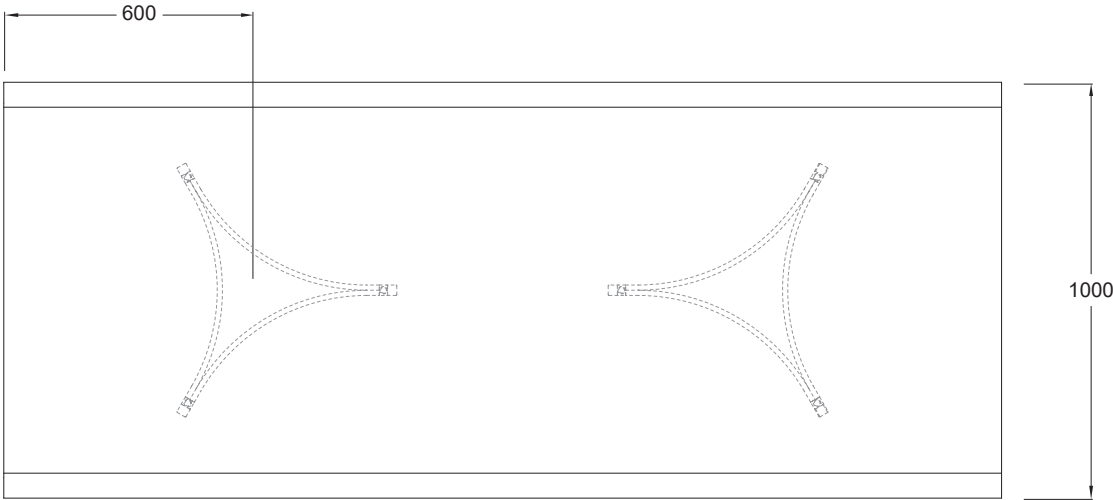

# CREVASSE BAR TABLE RANGE

CV-BTB[103].270x100

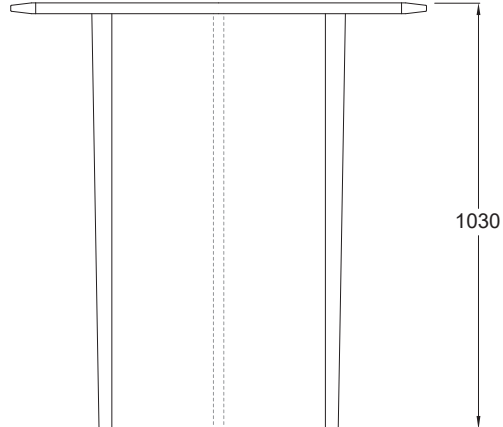
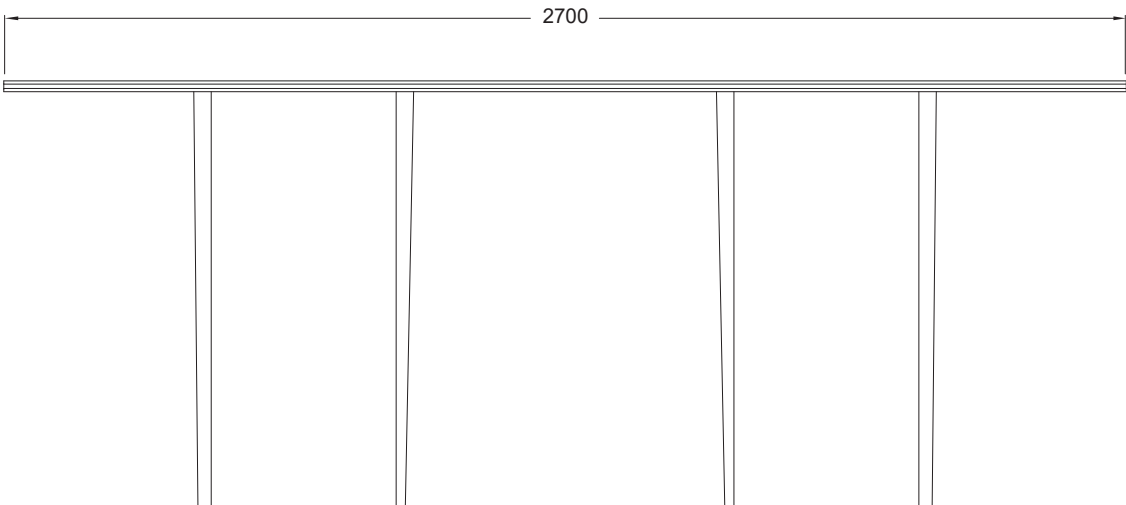
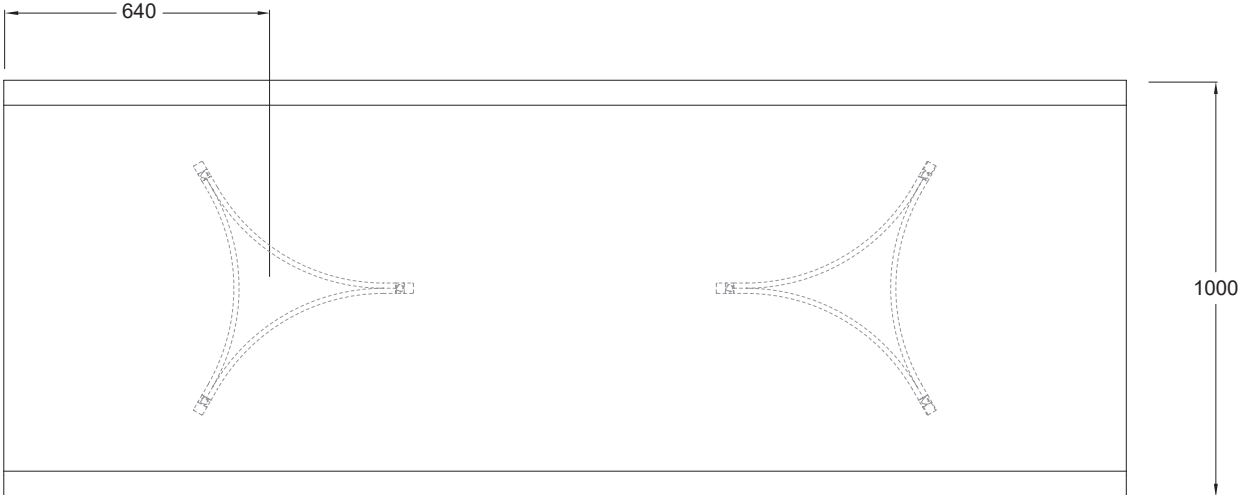

# CREVASSE BAR TABLE RANGE

CV-BTB[103].300x100

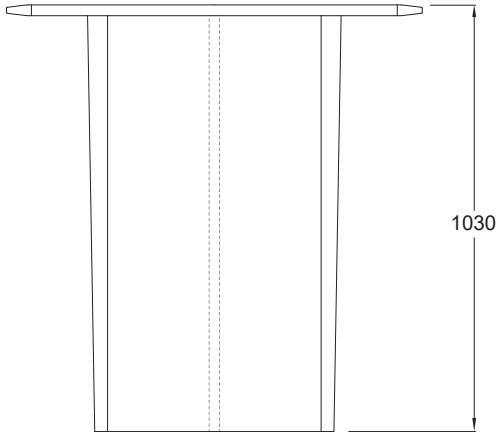
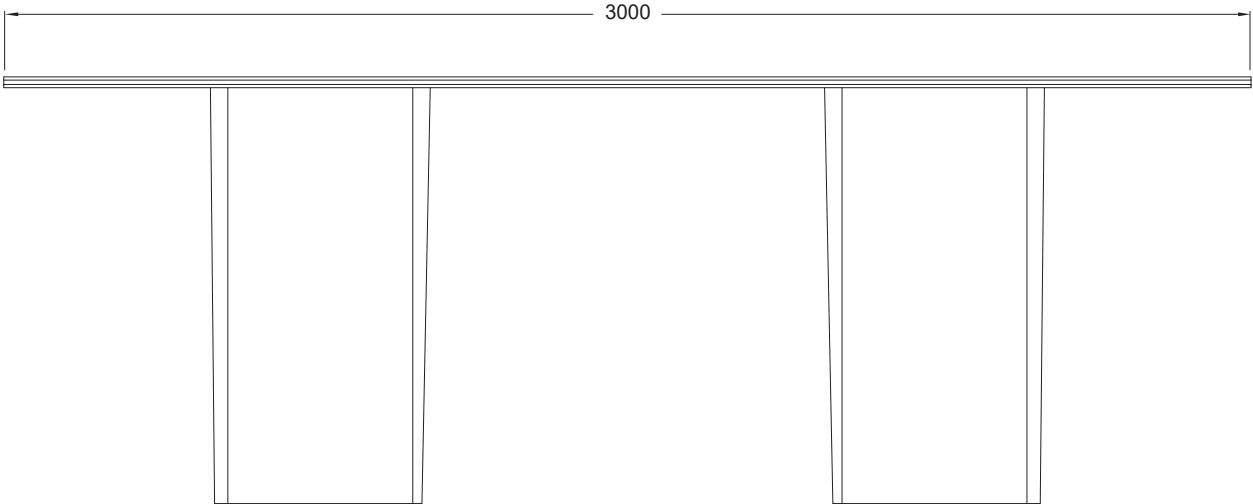
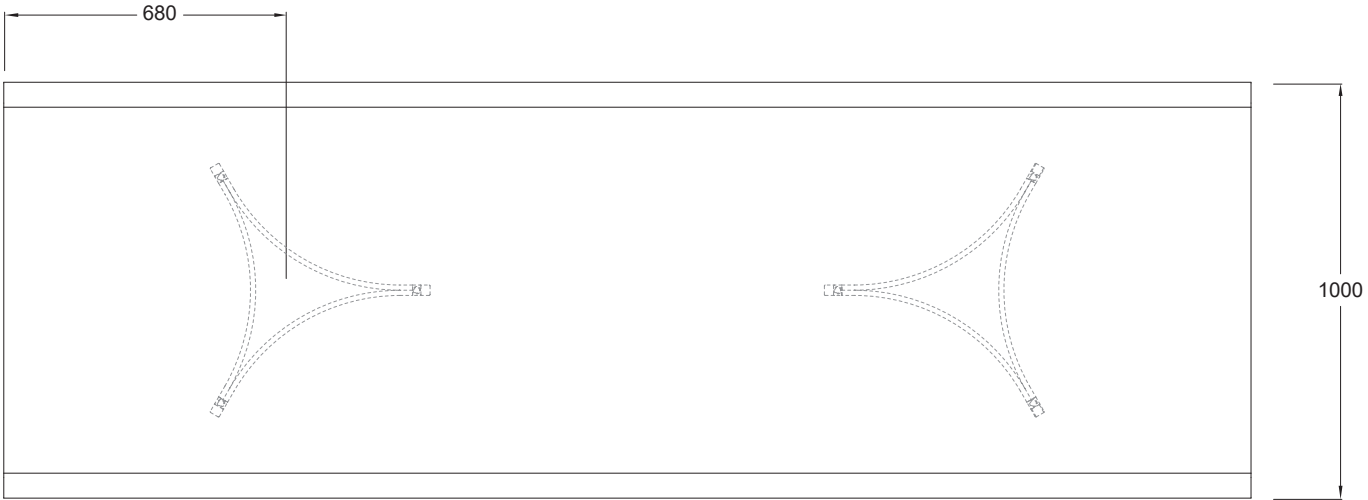

# CREVASSE BAR TABLE RANGE

CV-BTB[103].330x100

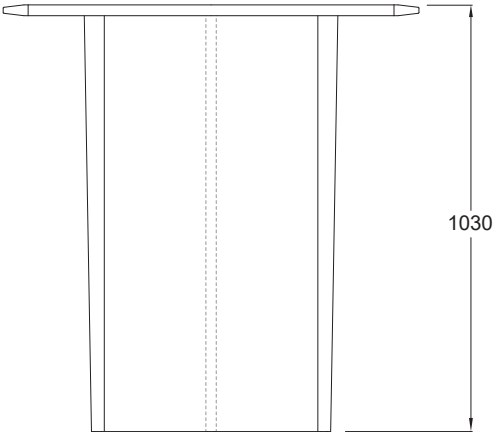
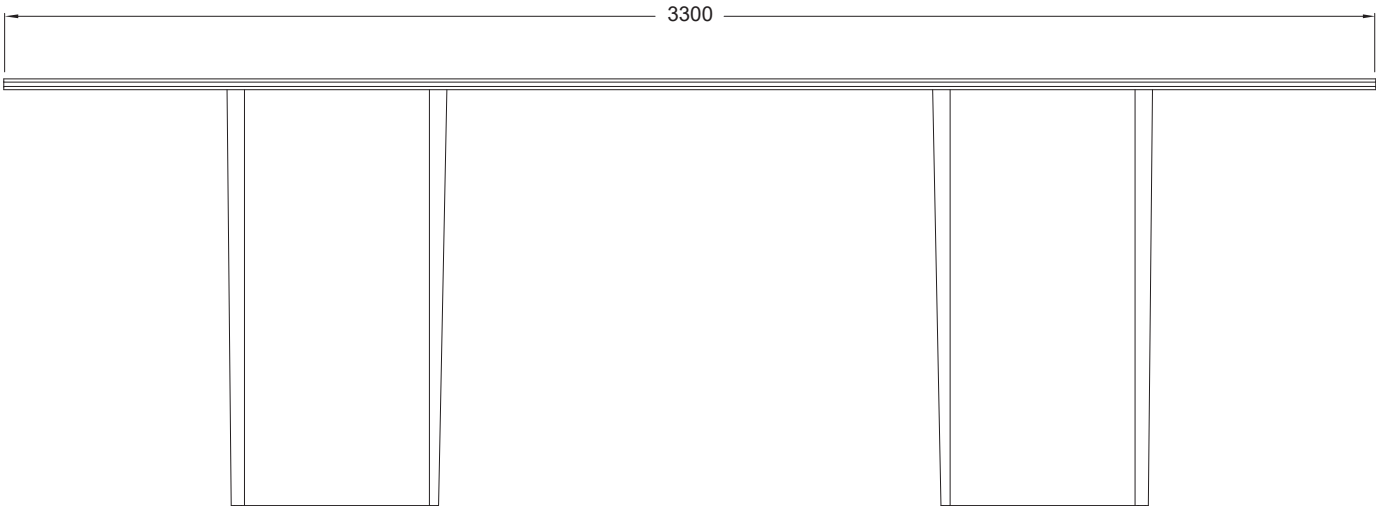

# CREVASSE BAR TABLE RANGE

CV-BTB[103].360x100

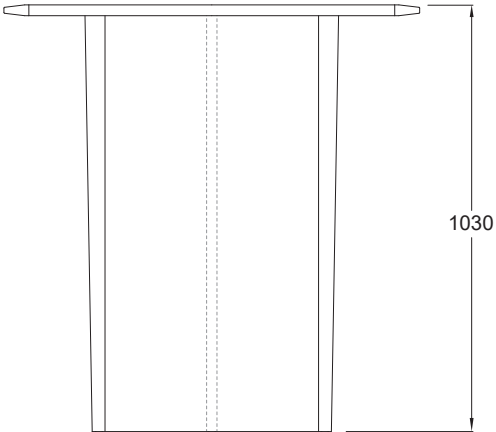
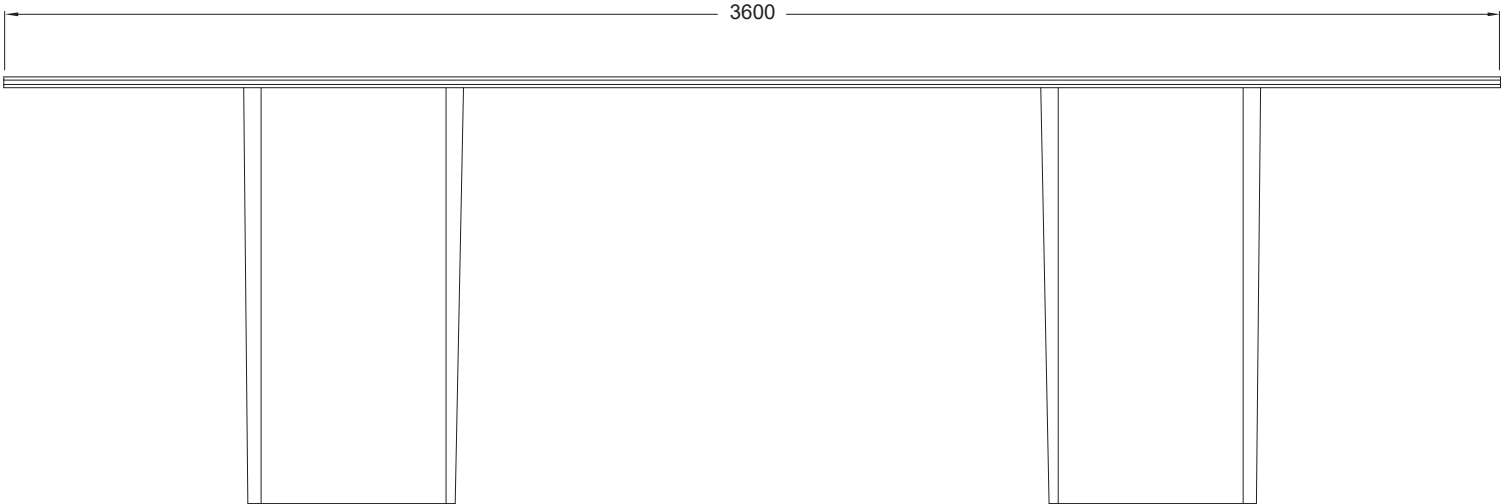

# CREVASSE BAR TABLE RANGE

CV-BTB[103].180x130

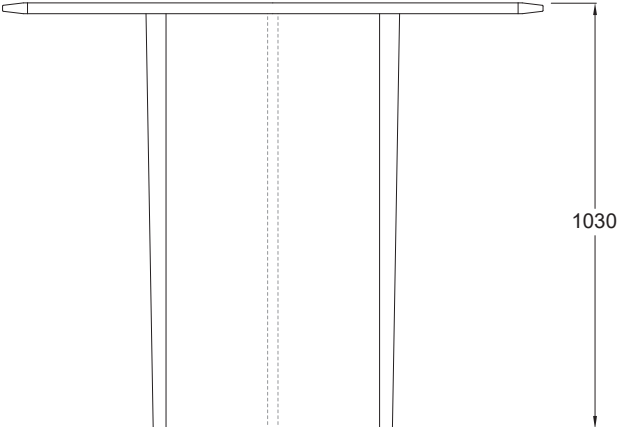
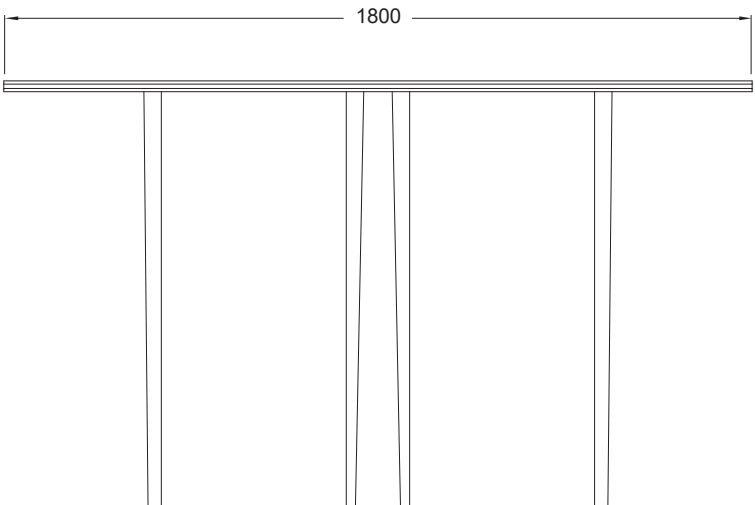
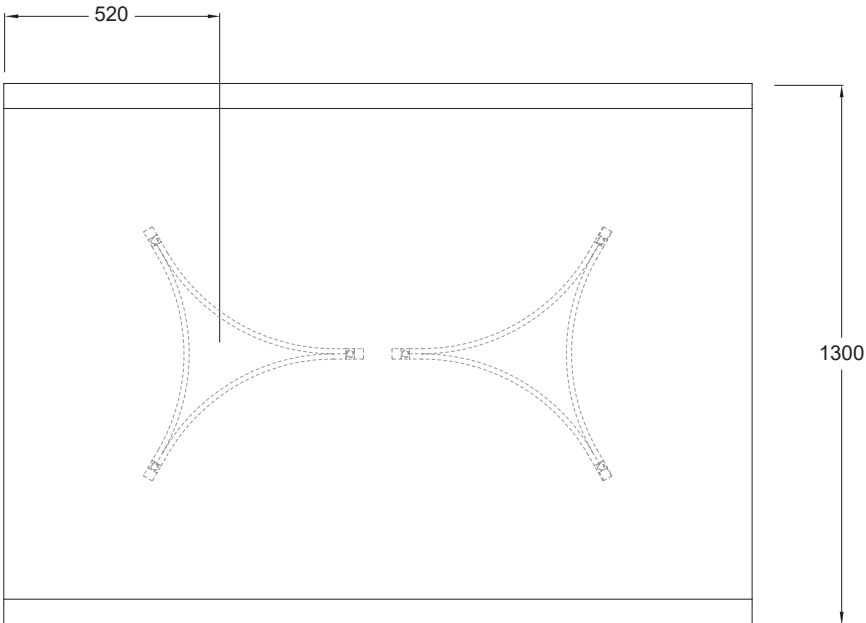



# CREVASSE BAR TABLE RANGE

CV-BTB[103].210x130

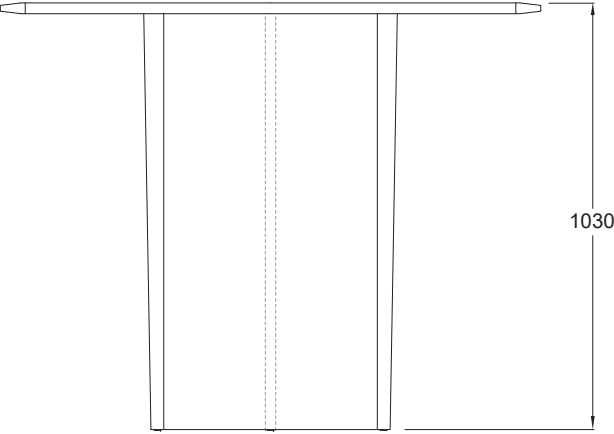
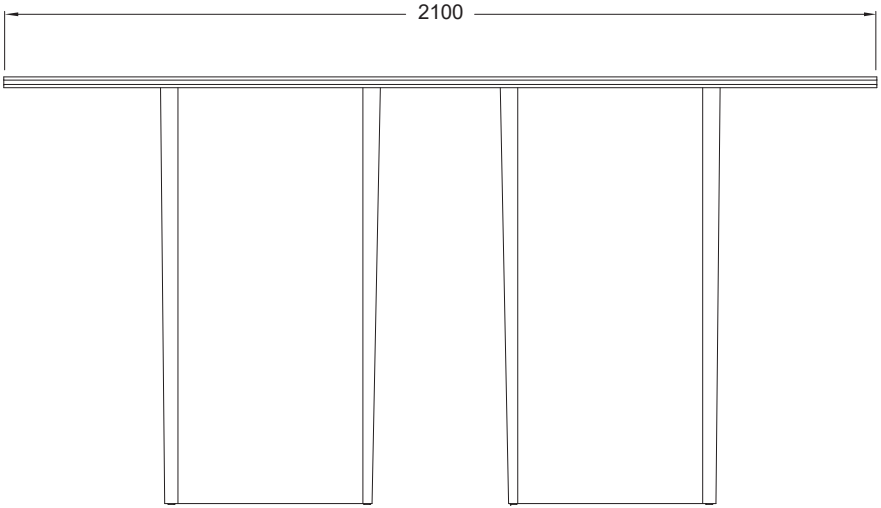
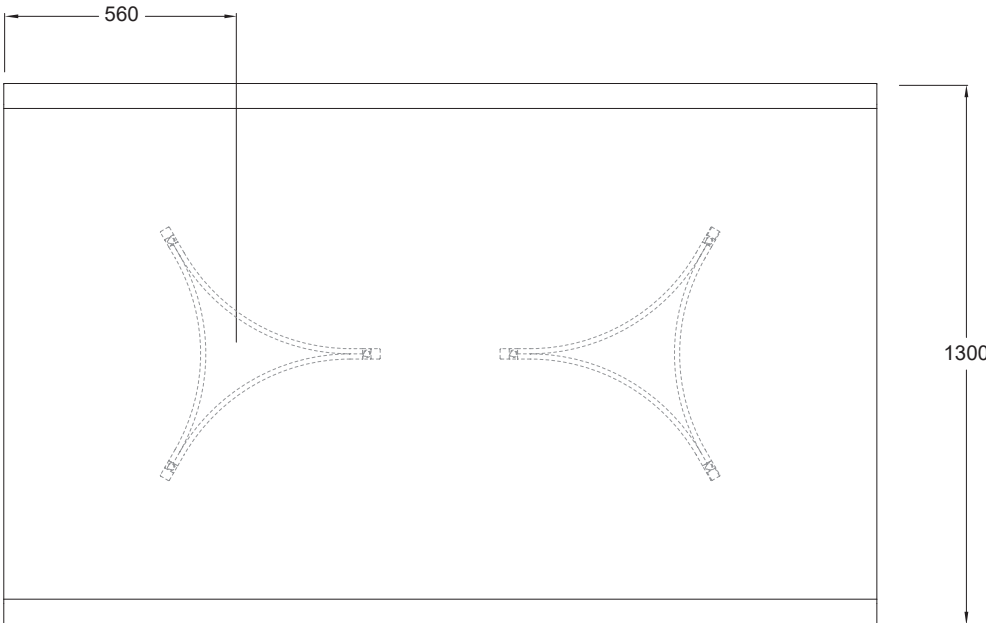

# CREVASSE BAR TABLE RANGE

CV-BTB[103].240x130

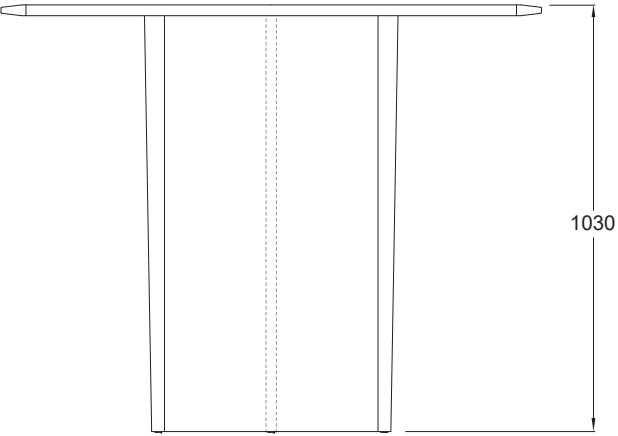
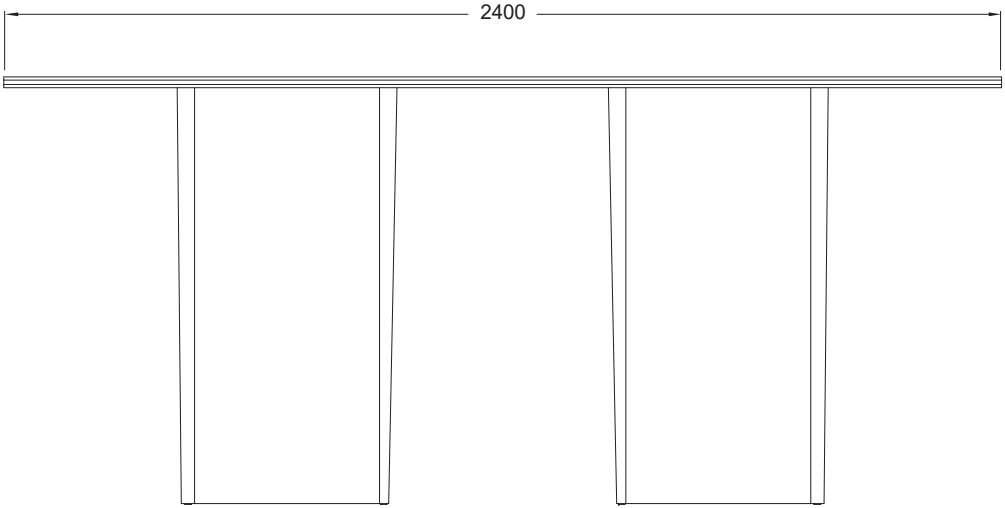
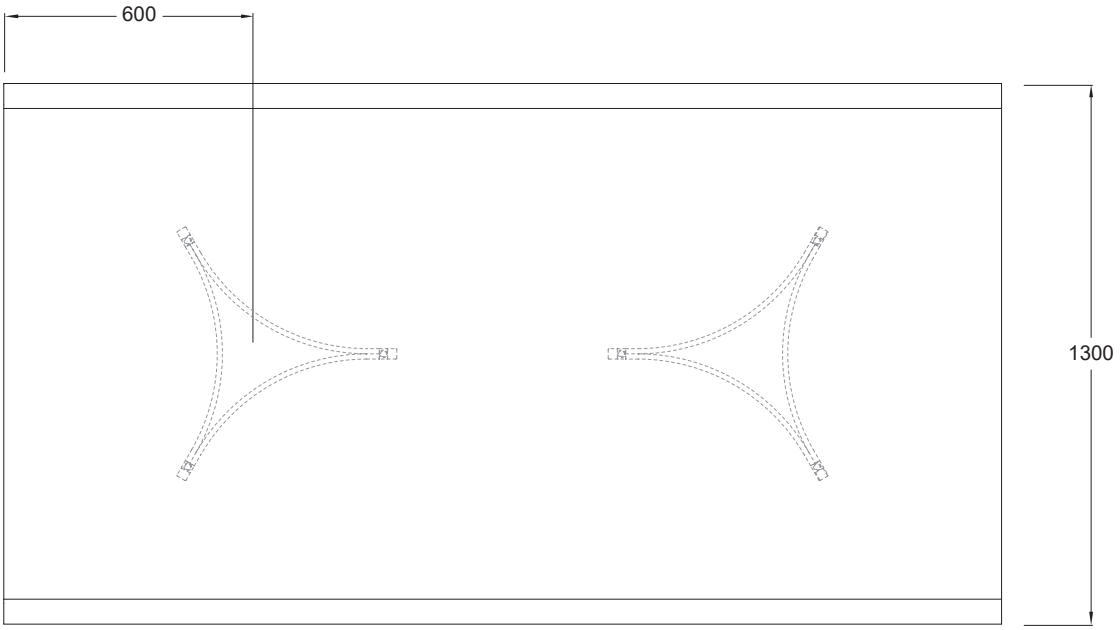

# CREVASSE BAR TABLE RANGE

CV-BTB[103].270x130

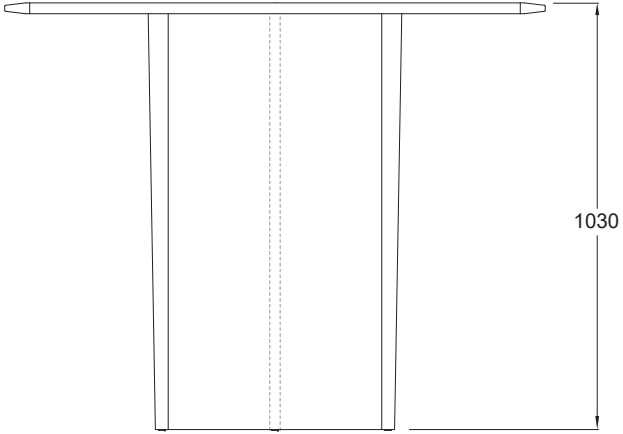
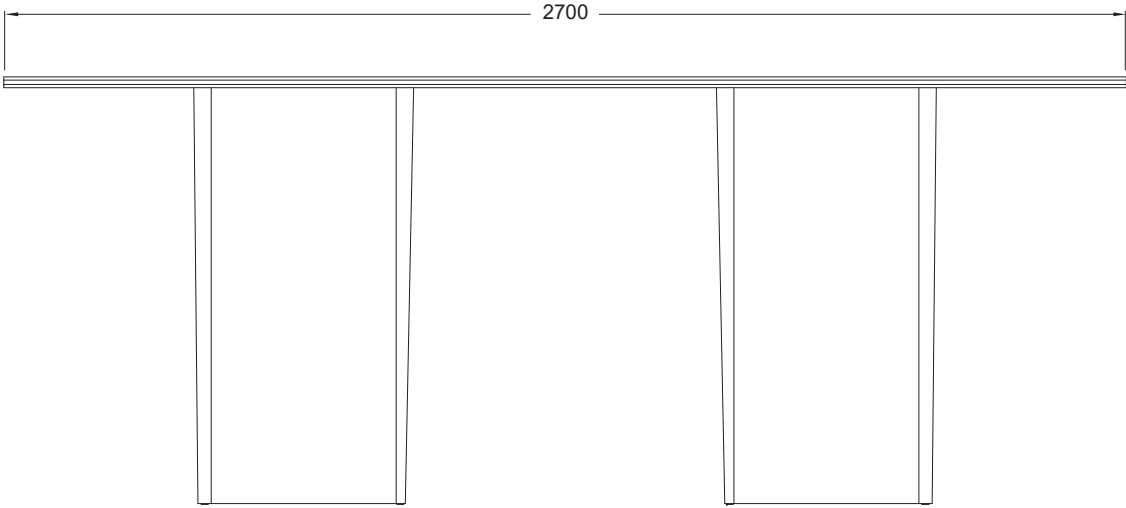
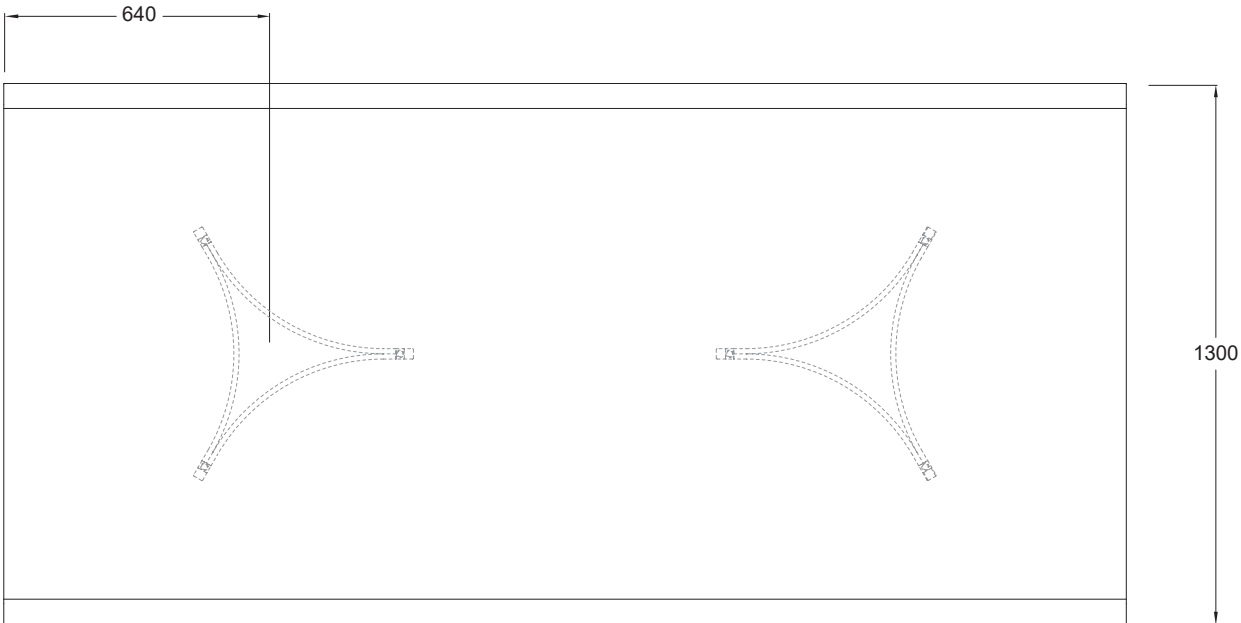

# CREVASSE BAR TABLE RANGE

CV-BTB[103].300x130

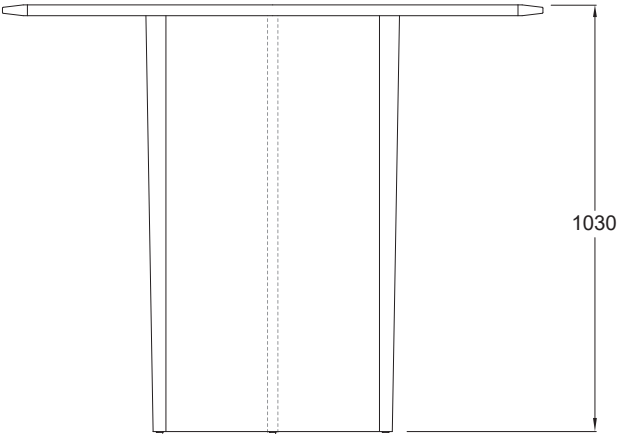
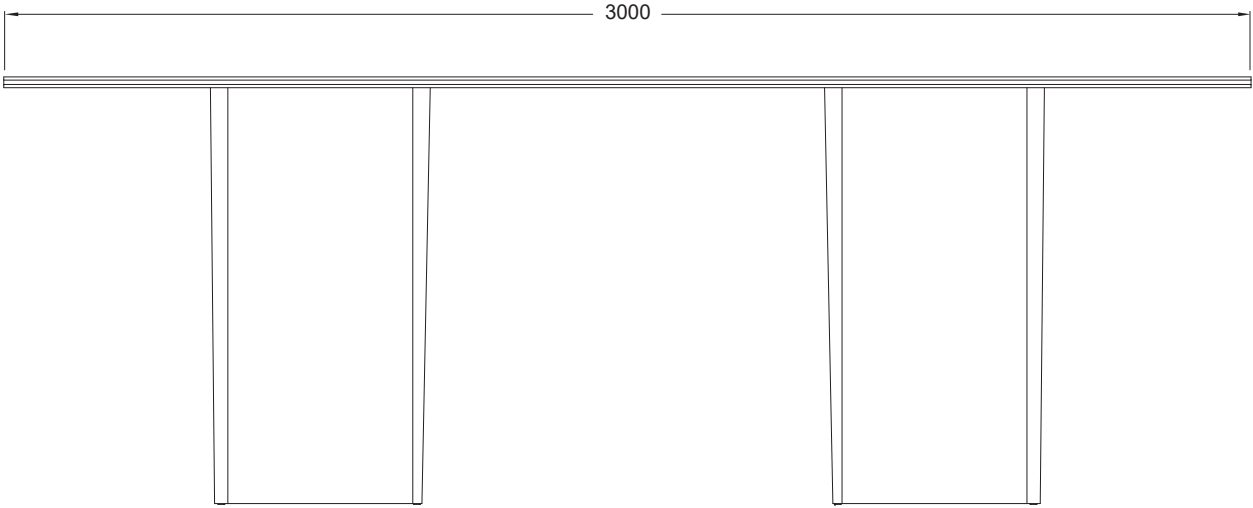
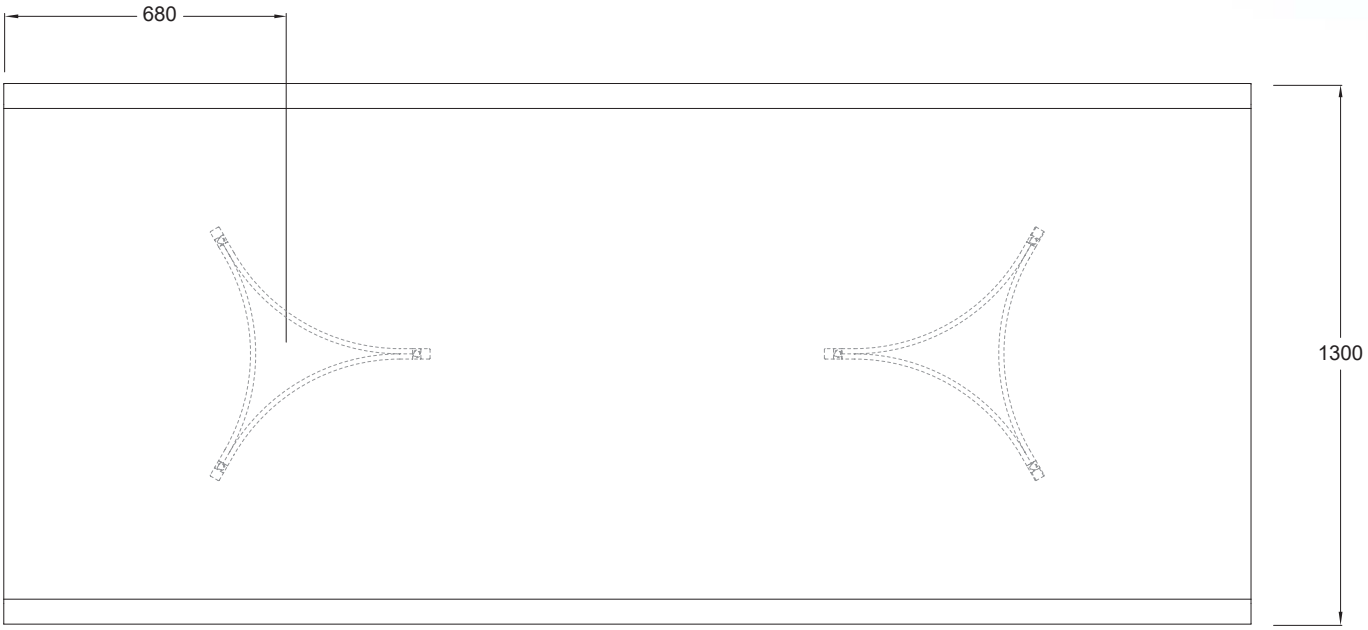

# CREVASSE BAR TABLE RANGE

CV-BTB[103].330x130

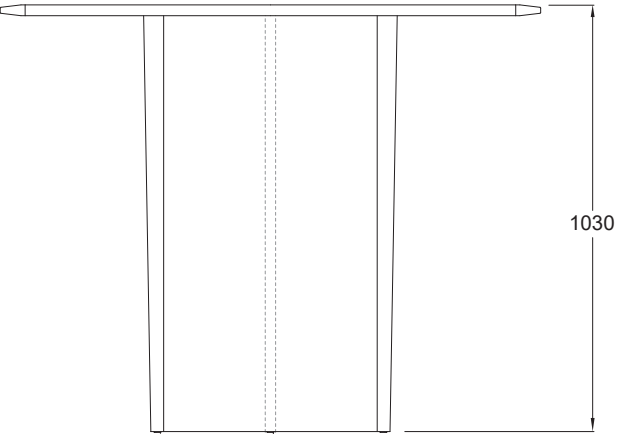
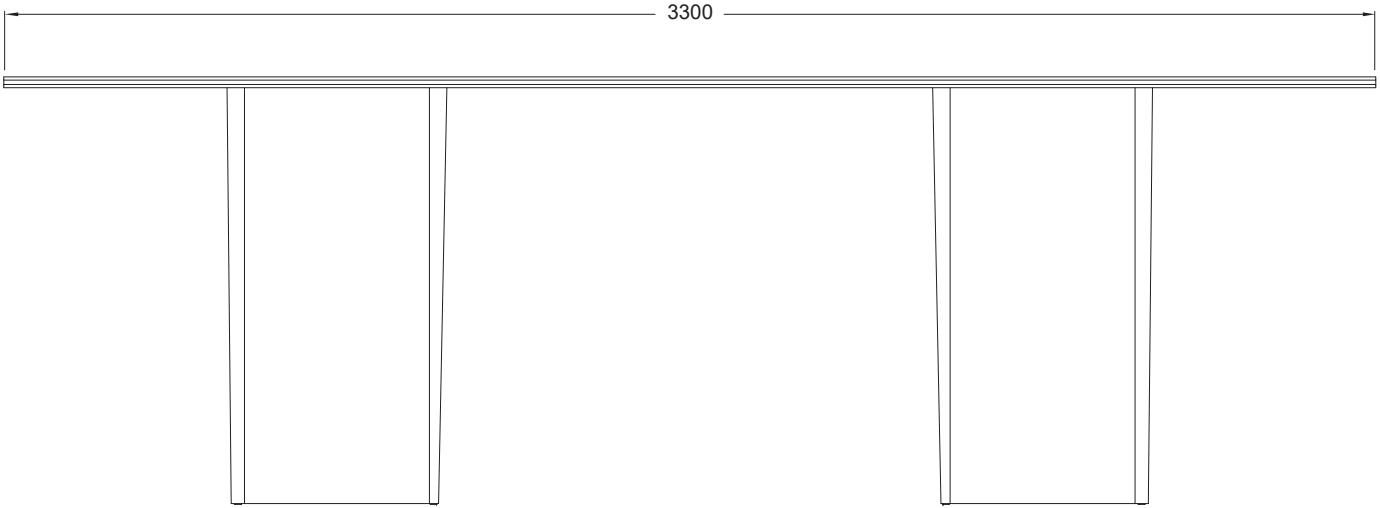
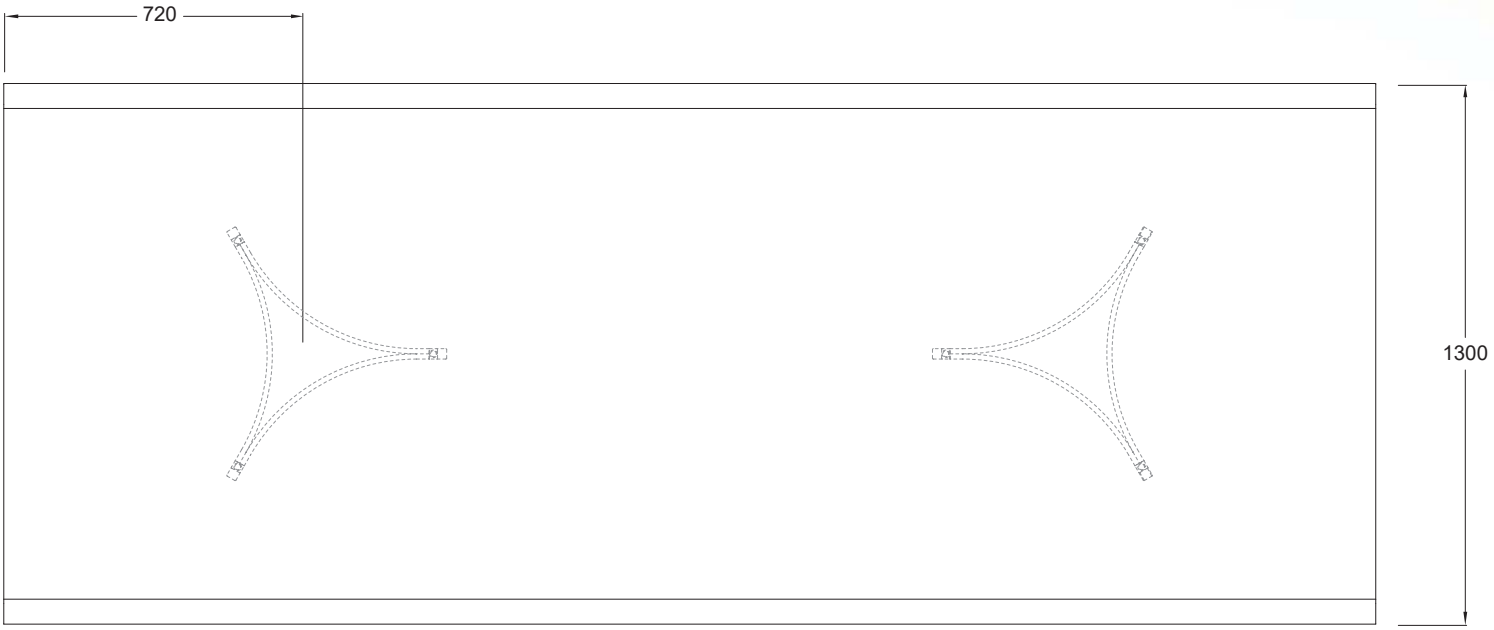

# CREVASSE BAR TABLE RANGE

CV-BTB[103].360x130

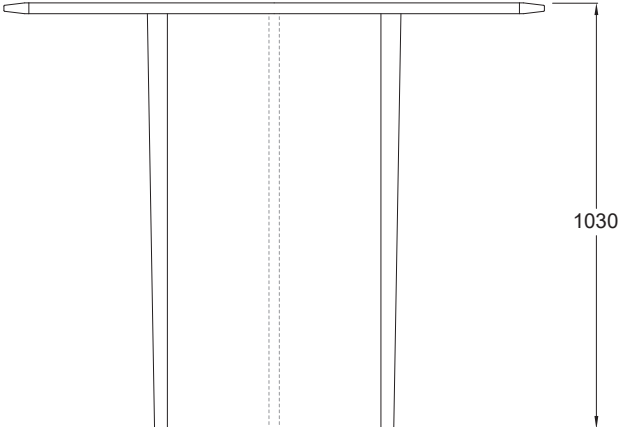
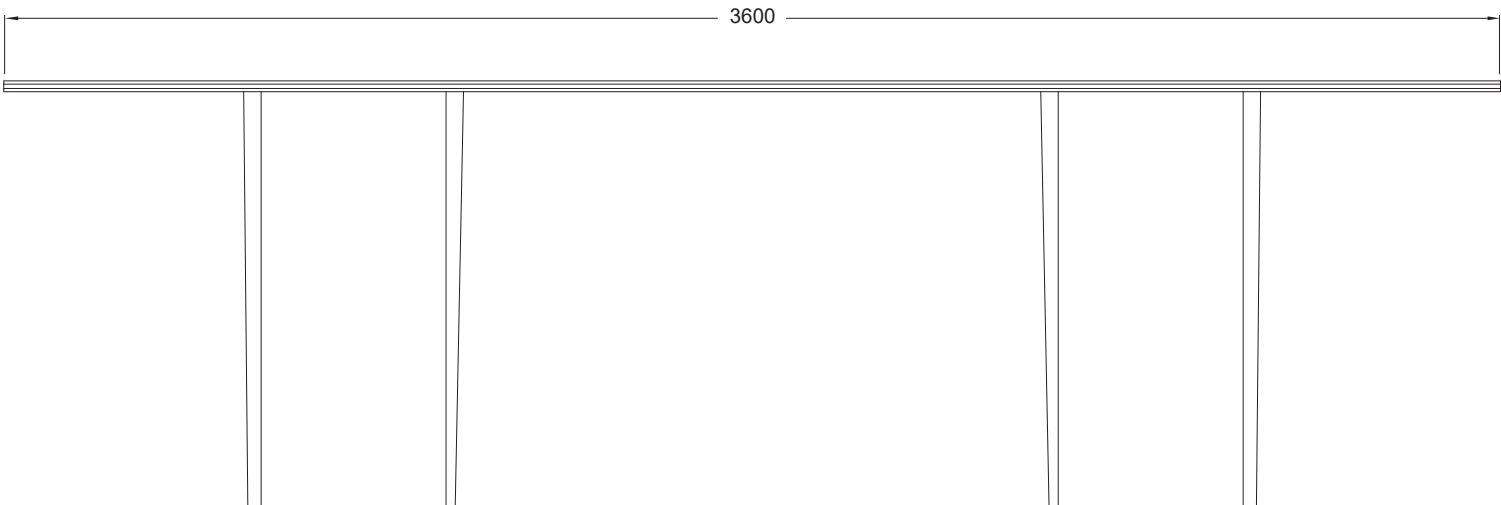

# CREVASSE BAR TABLE RANGE

CV-BTB[103].300x150

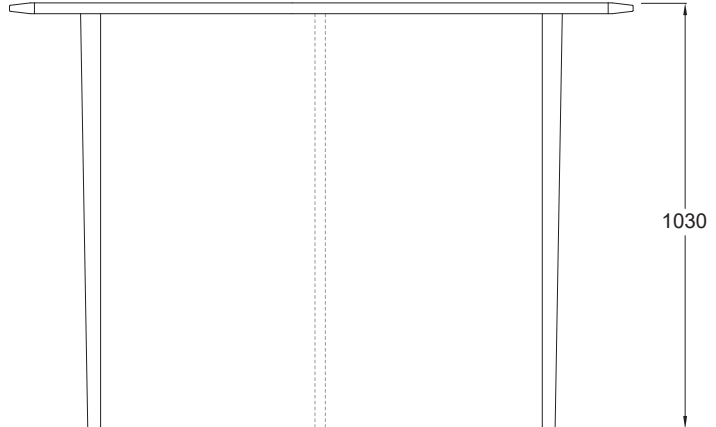
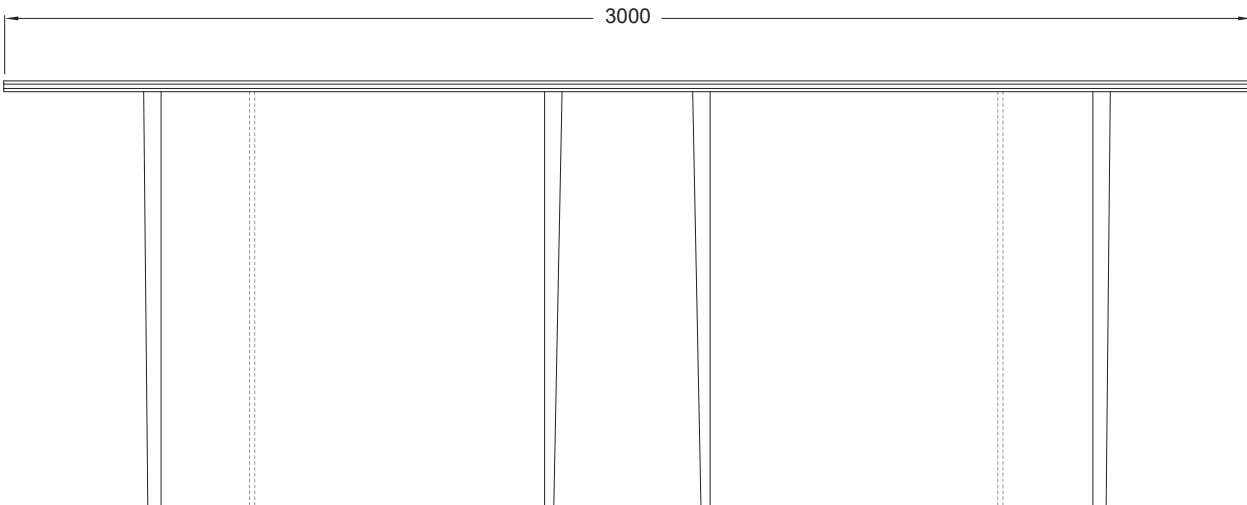
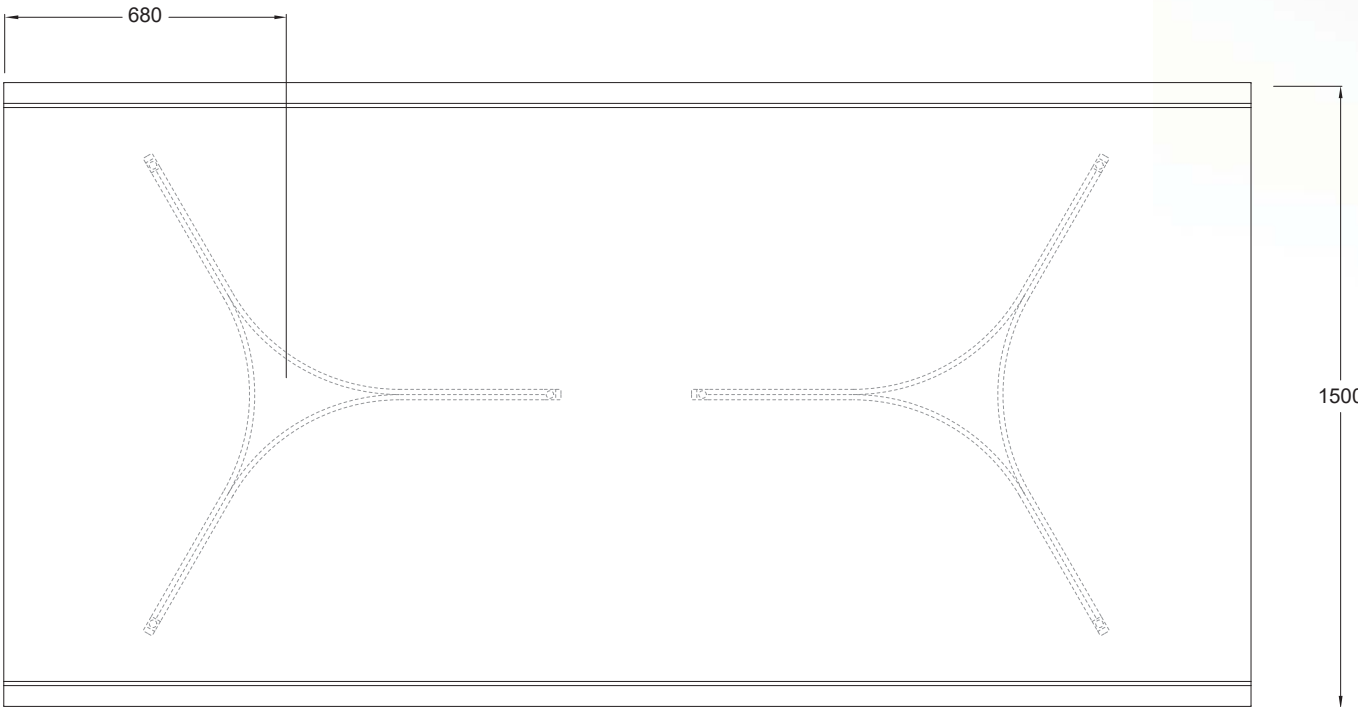
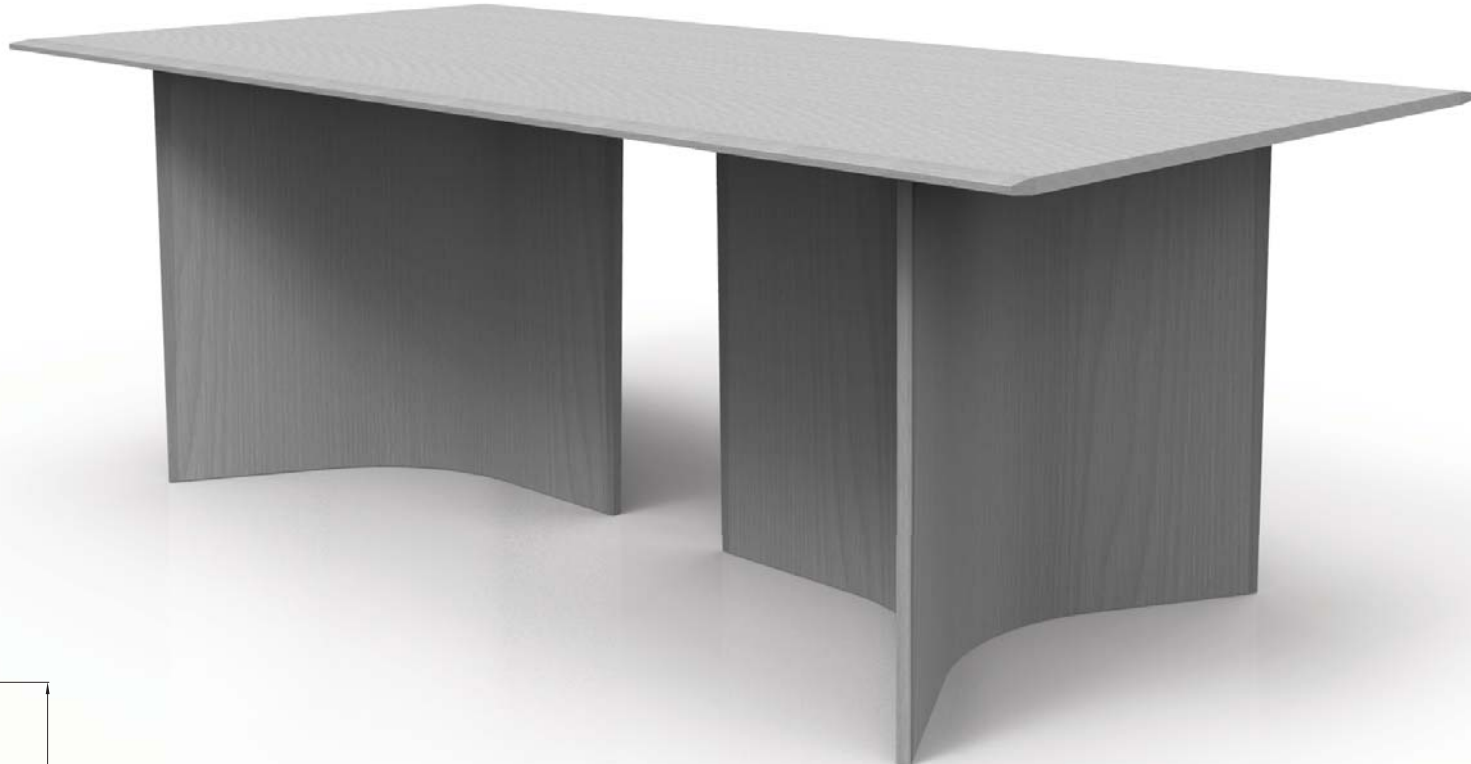

# CREVASSE BAR TABLE RANGE

CV-BTB[103].330x150

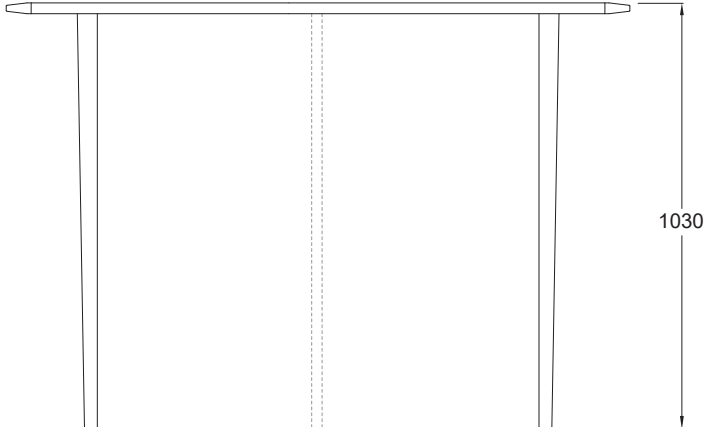
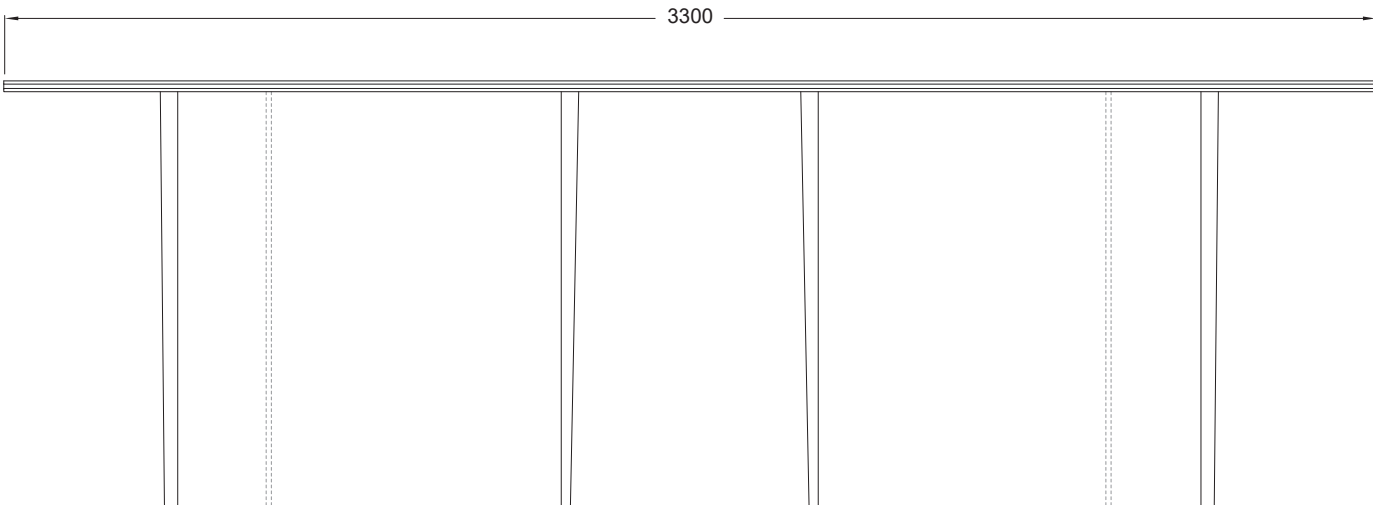
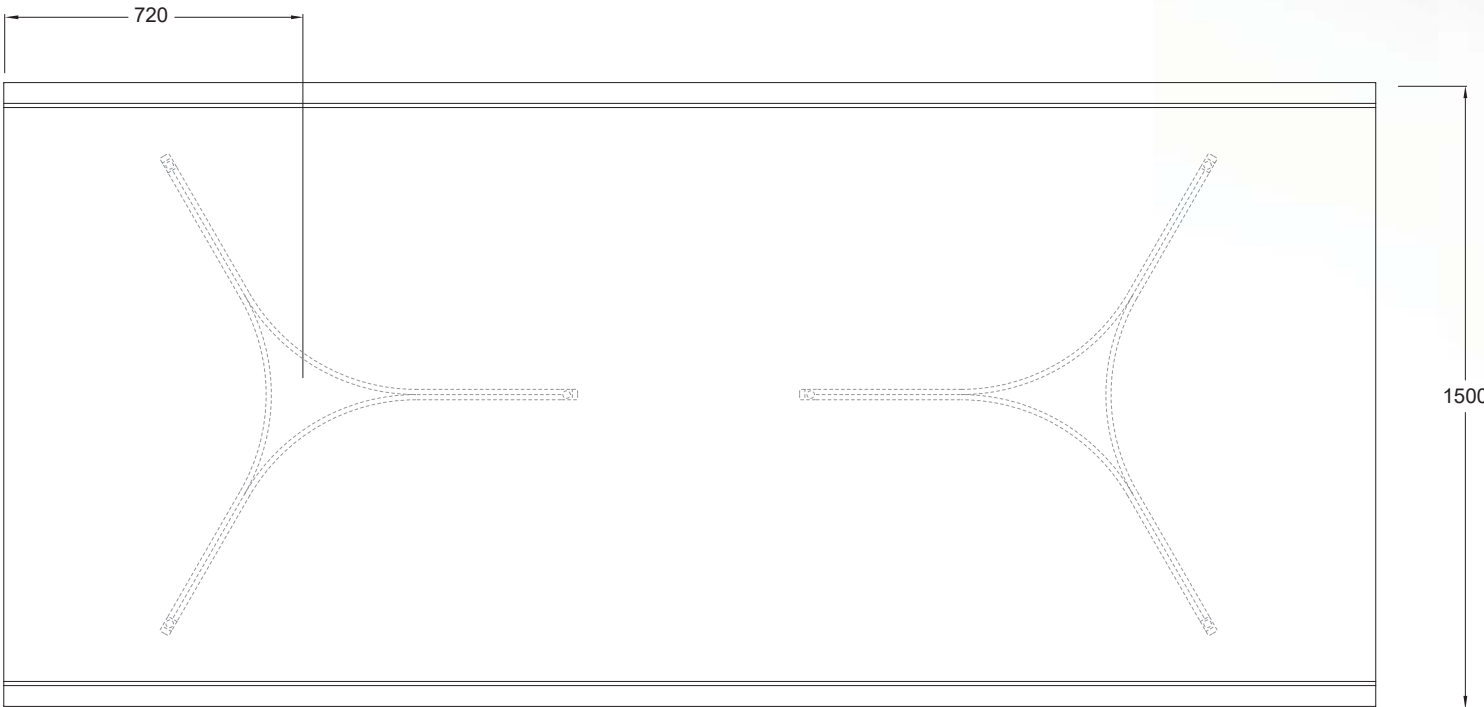



# CREVASSE BAR TABLE RANGE

CV-BTB[103].360x150

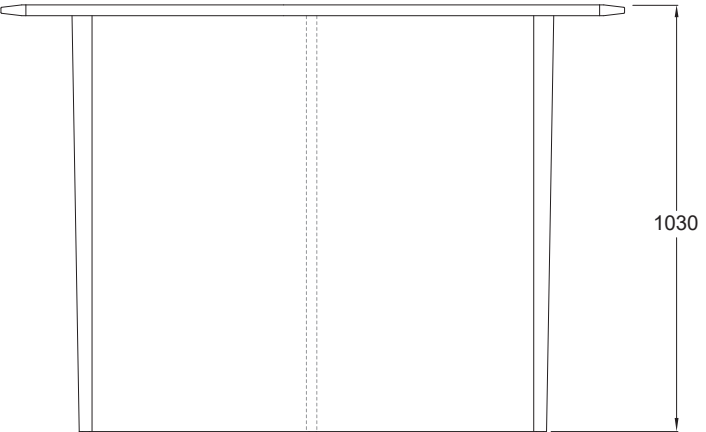
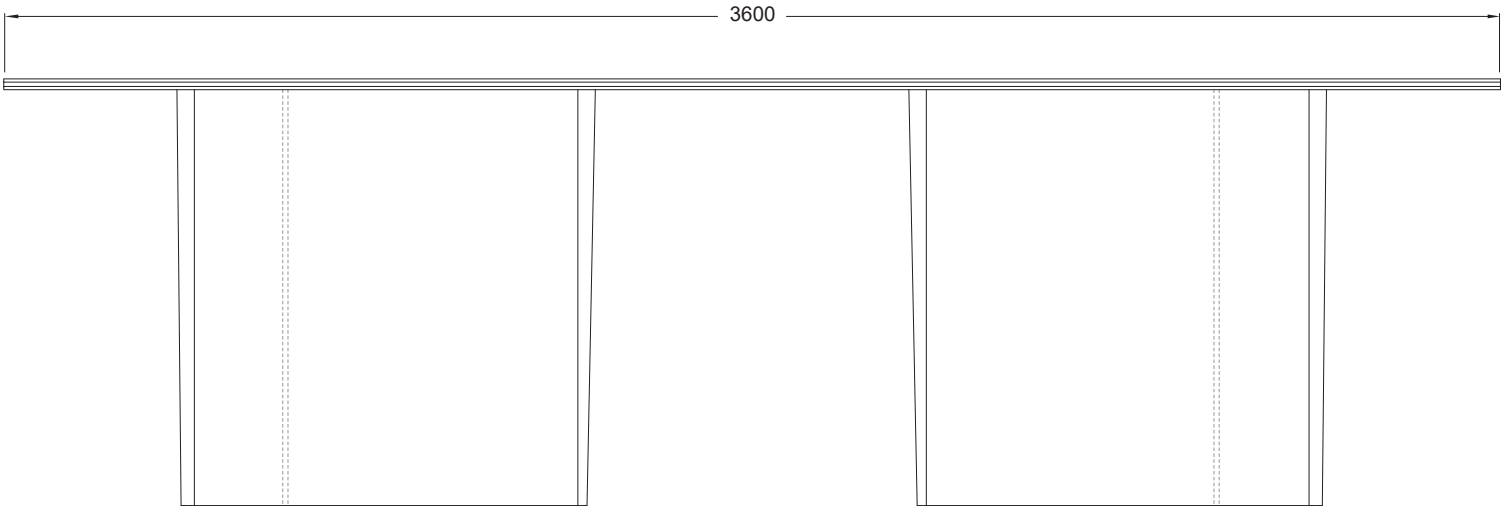
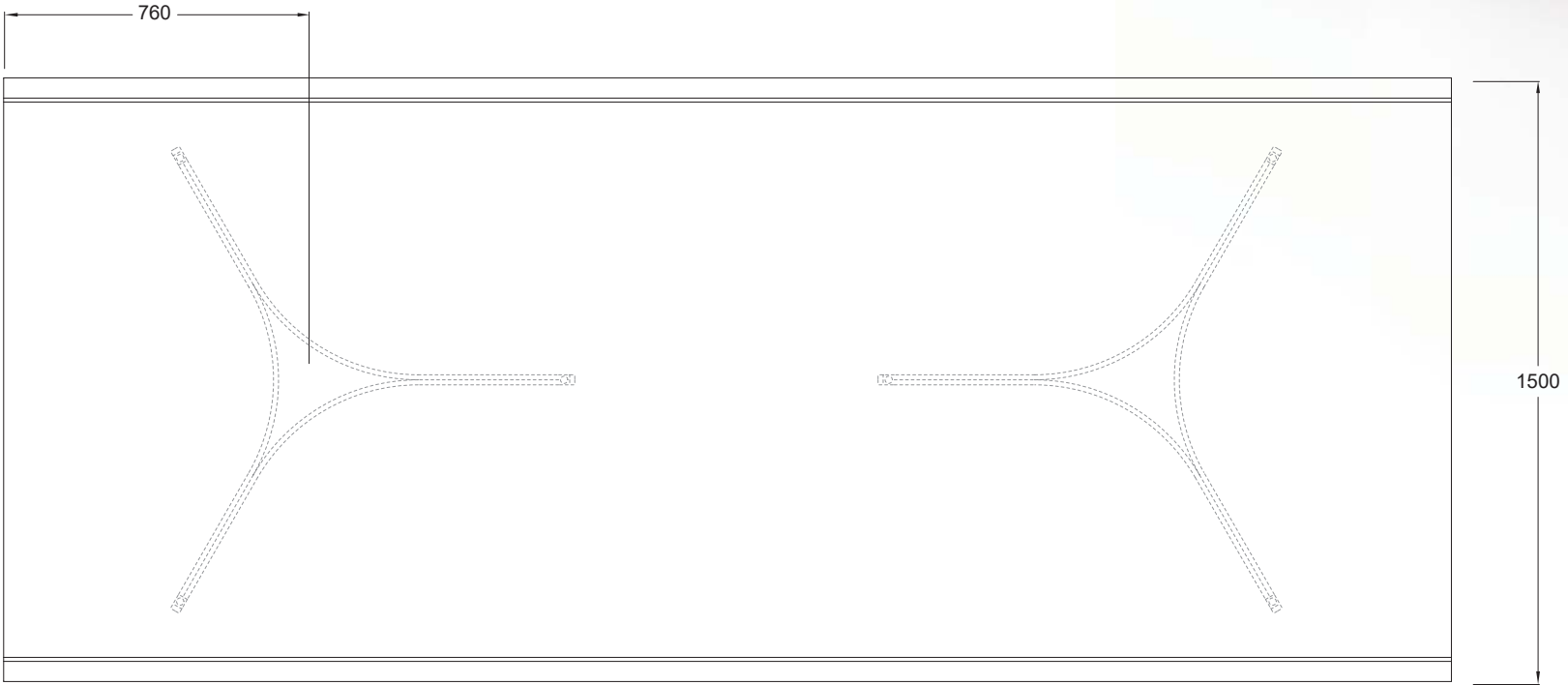
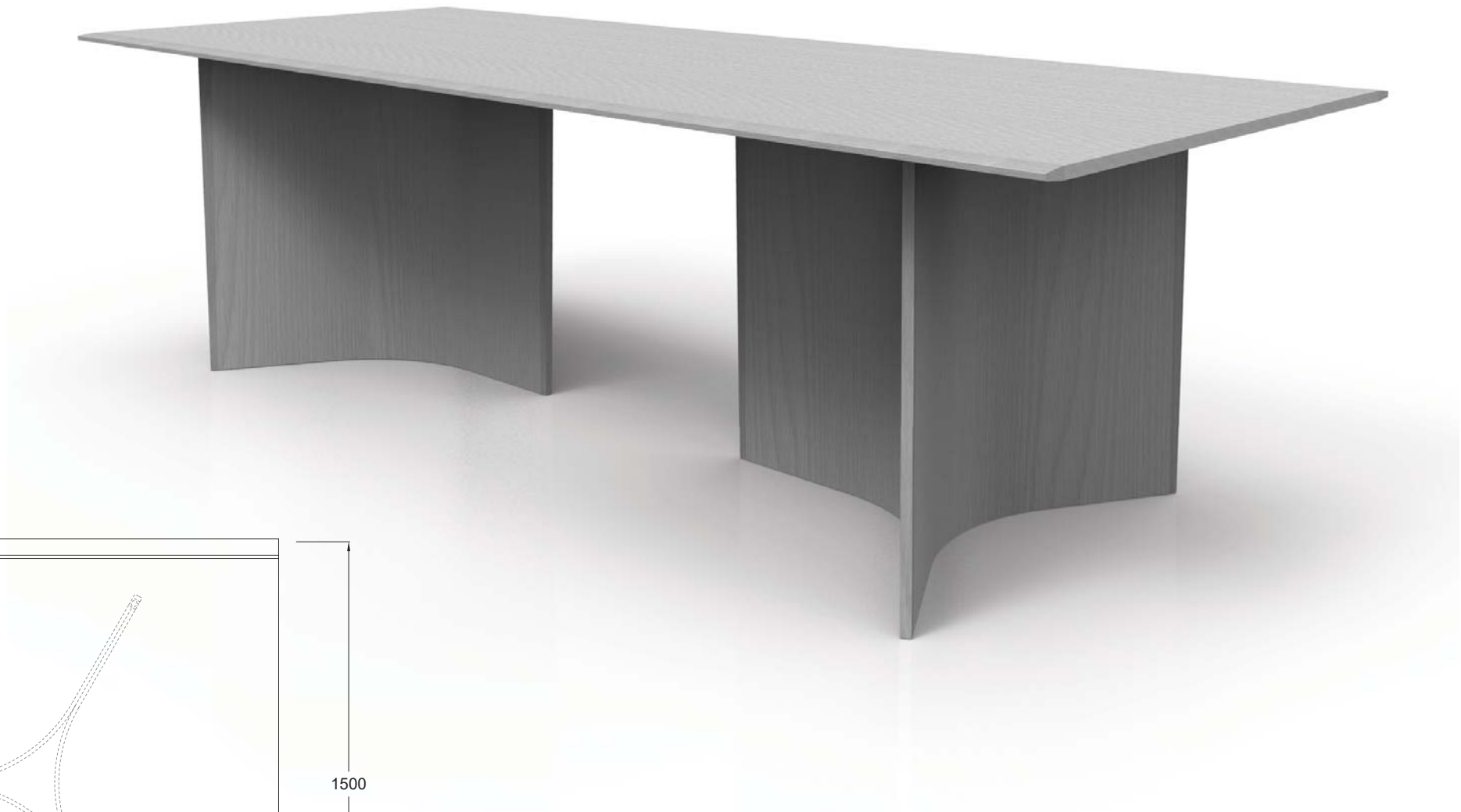

# CREVASSE BAR TABLE RANGE

CV-BTB[103].300x180

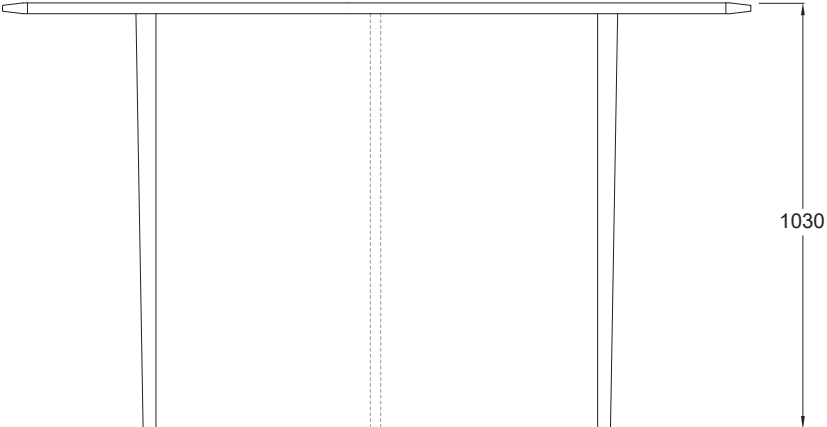
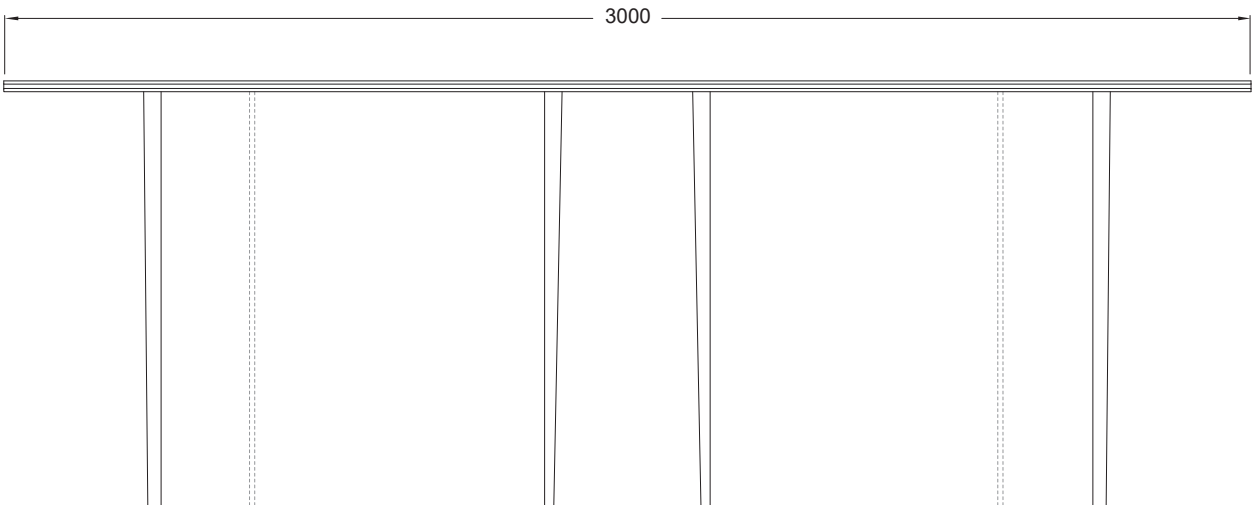
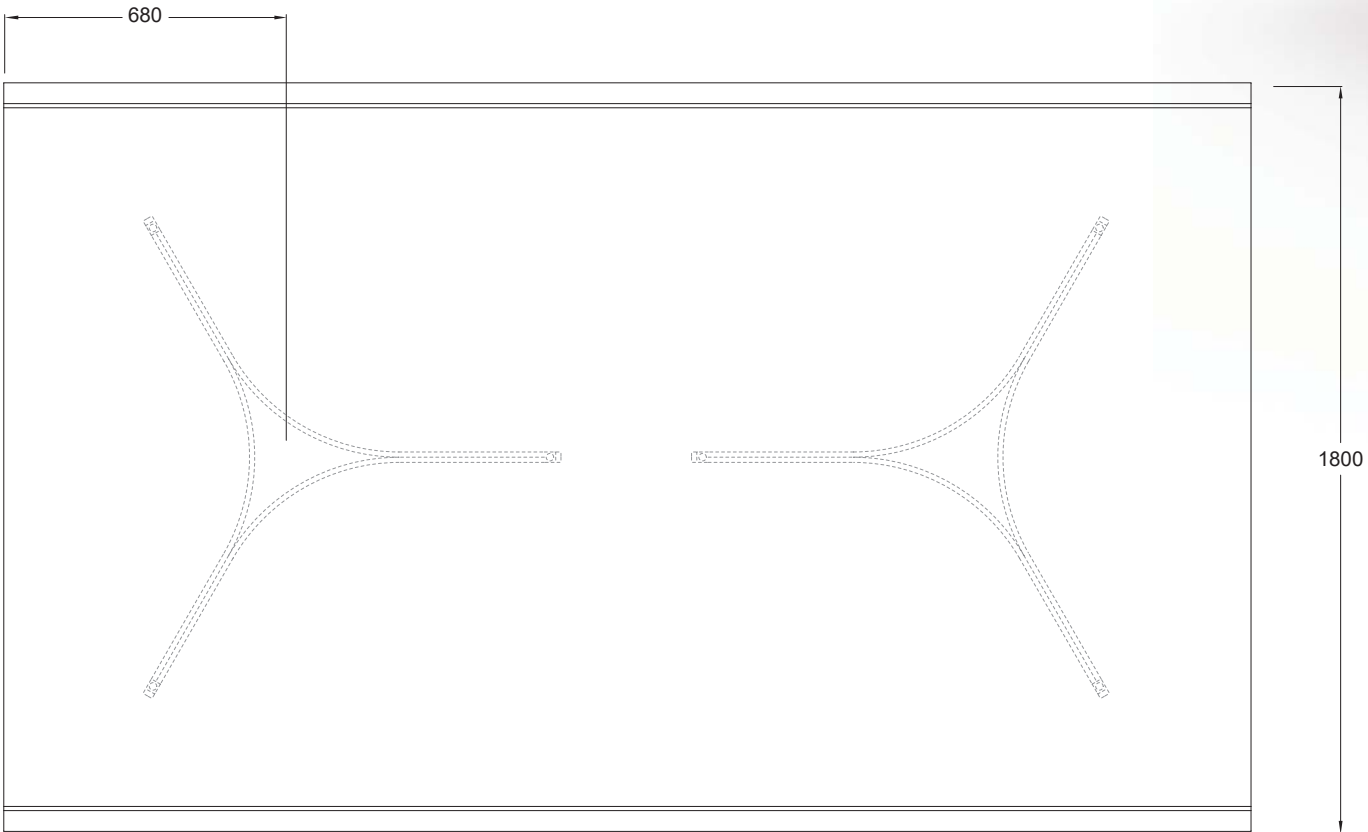
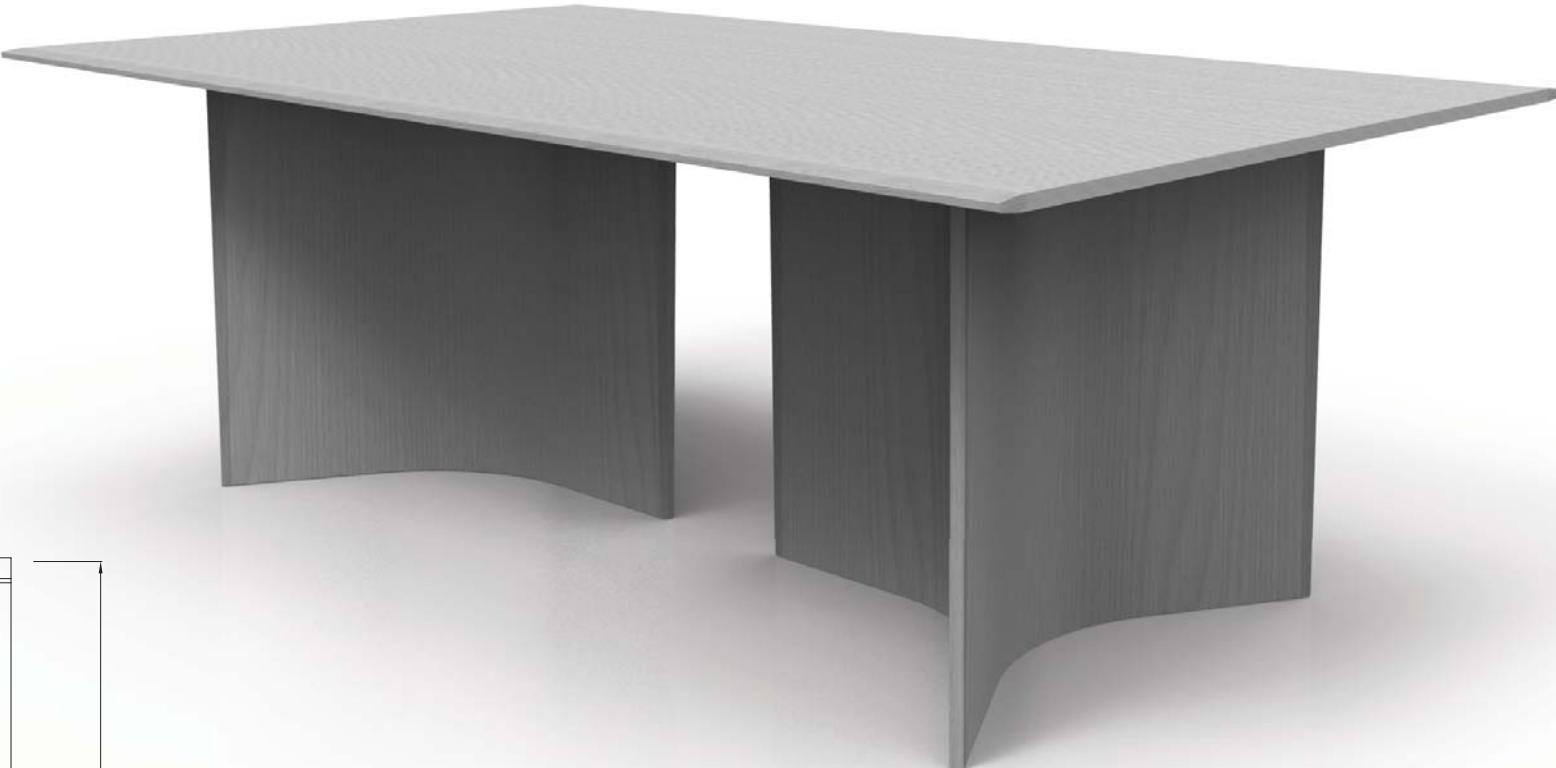

# CREVASSE BAR TABLE RANGE

CV-BTB[103].330x180

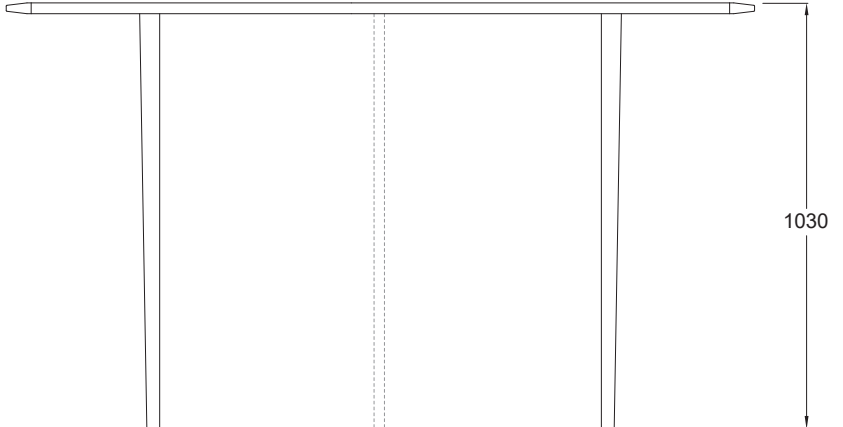
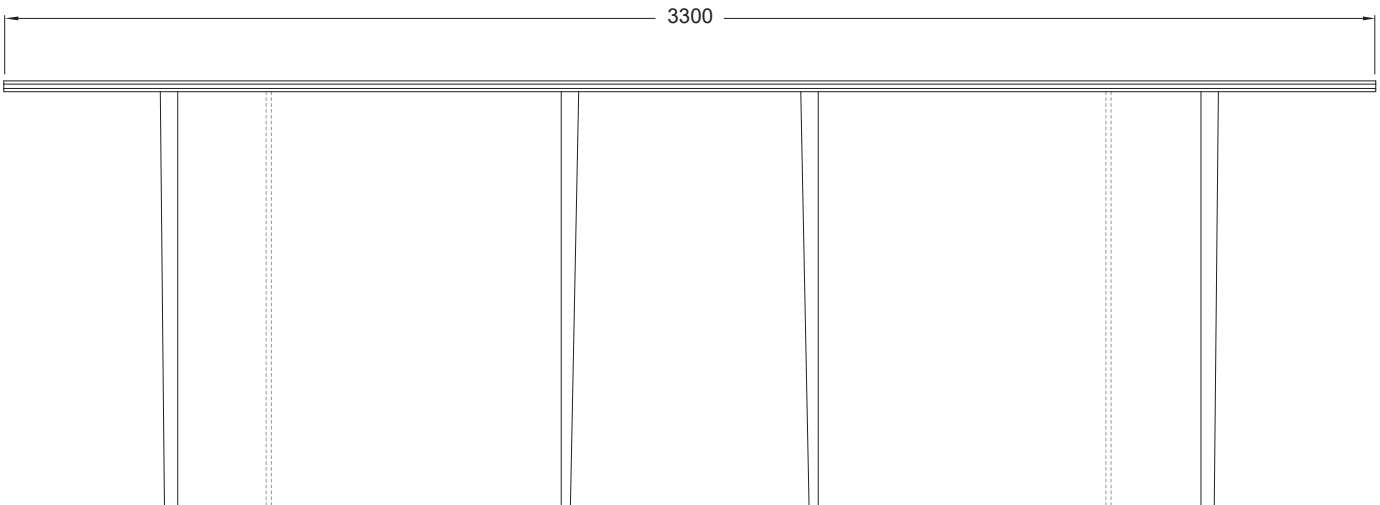
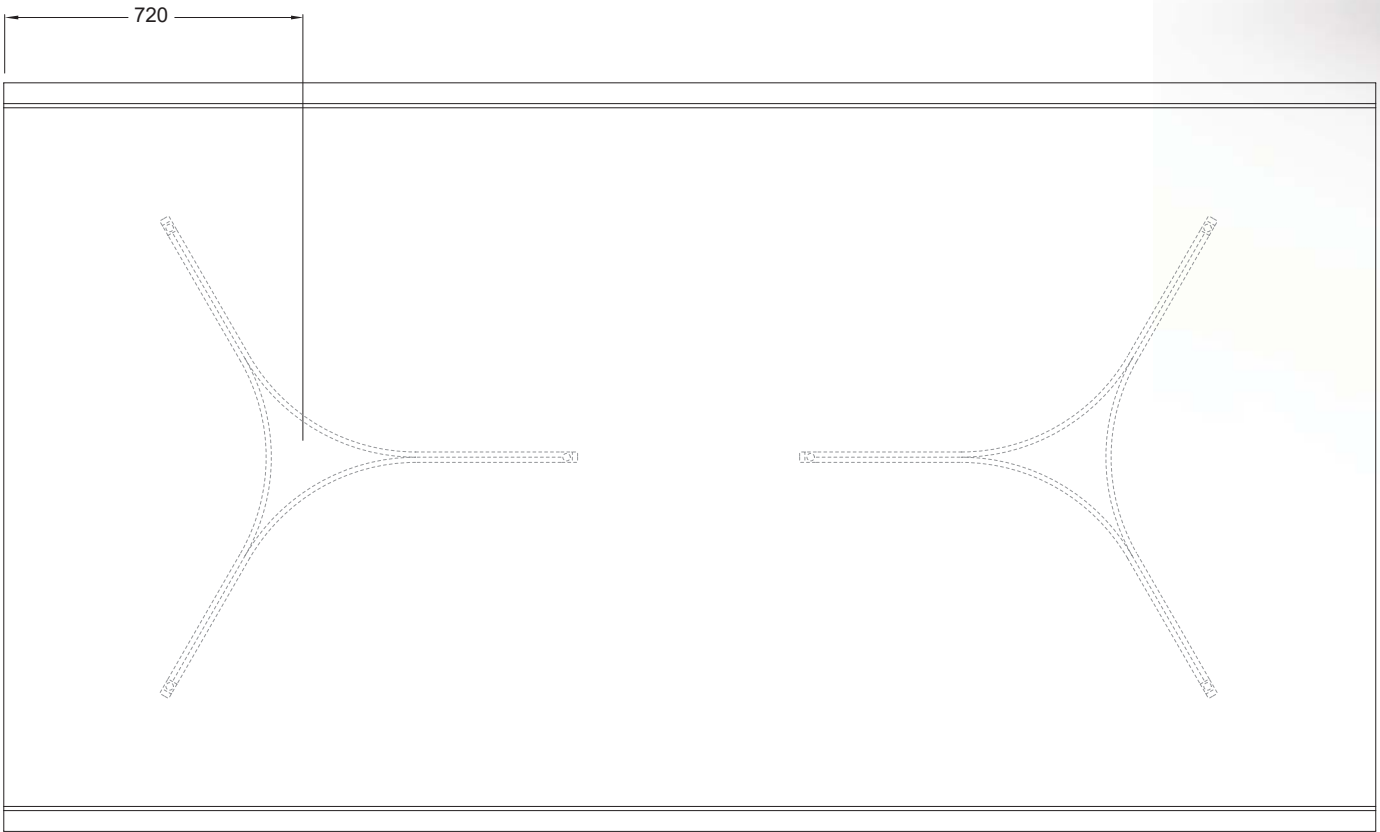
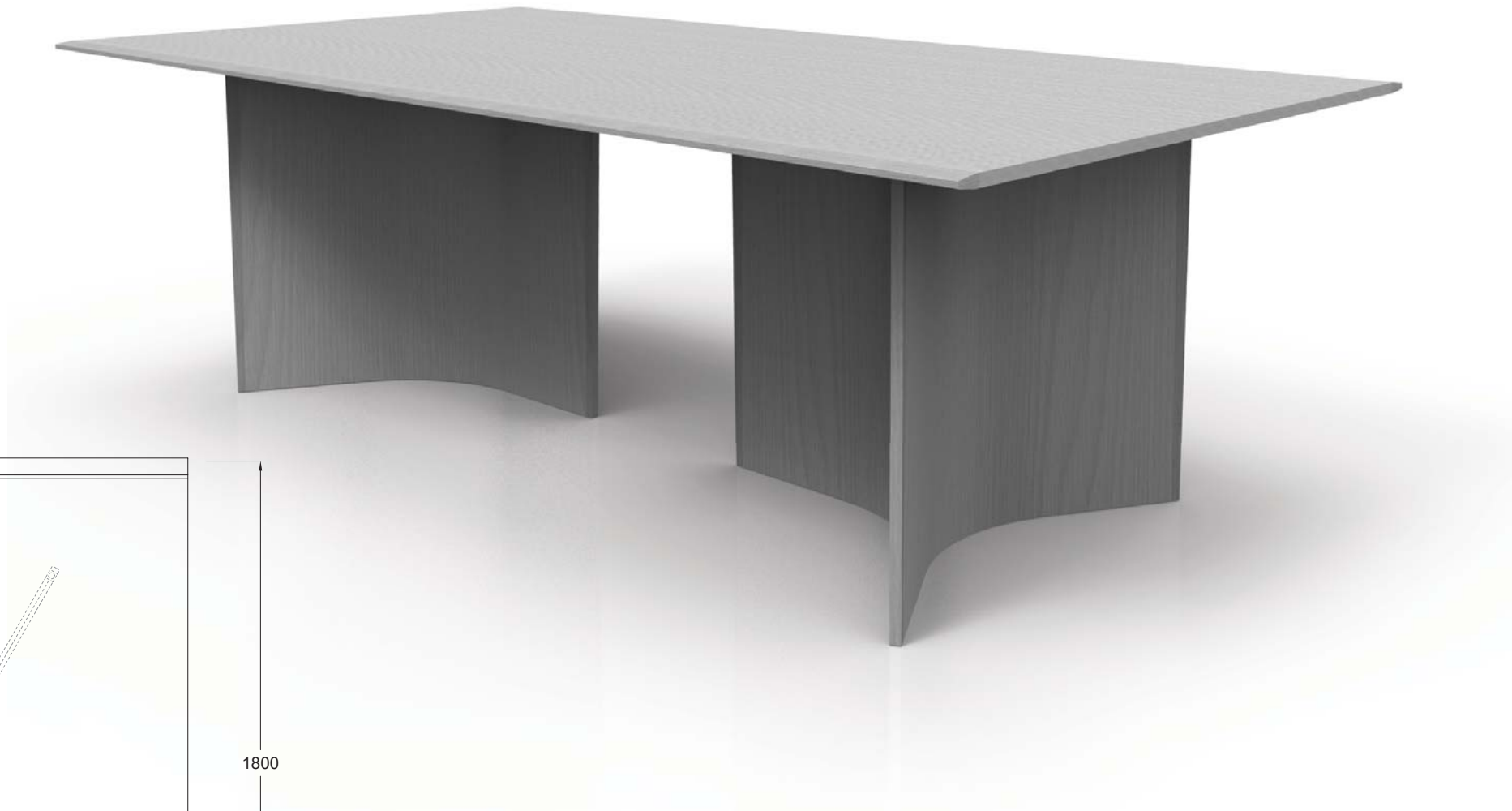

# CREVASSE BAR TABLE RANGE

CV-BTB[103].360x180

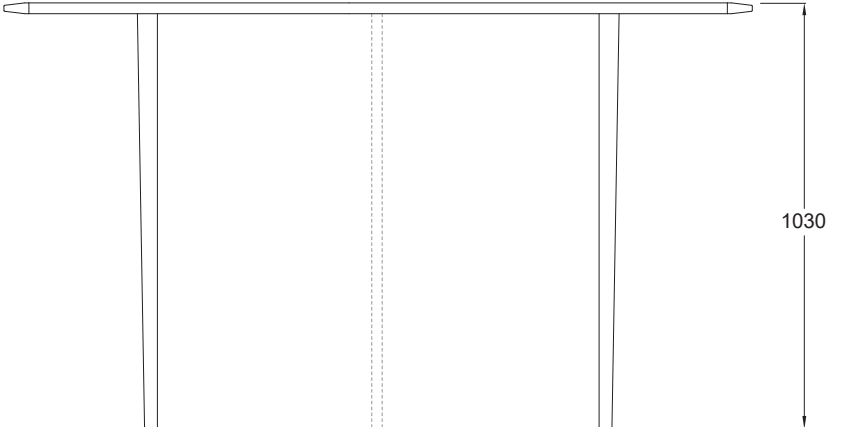
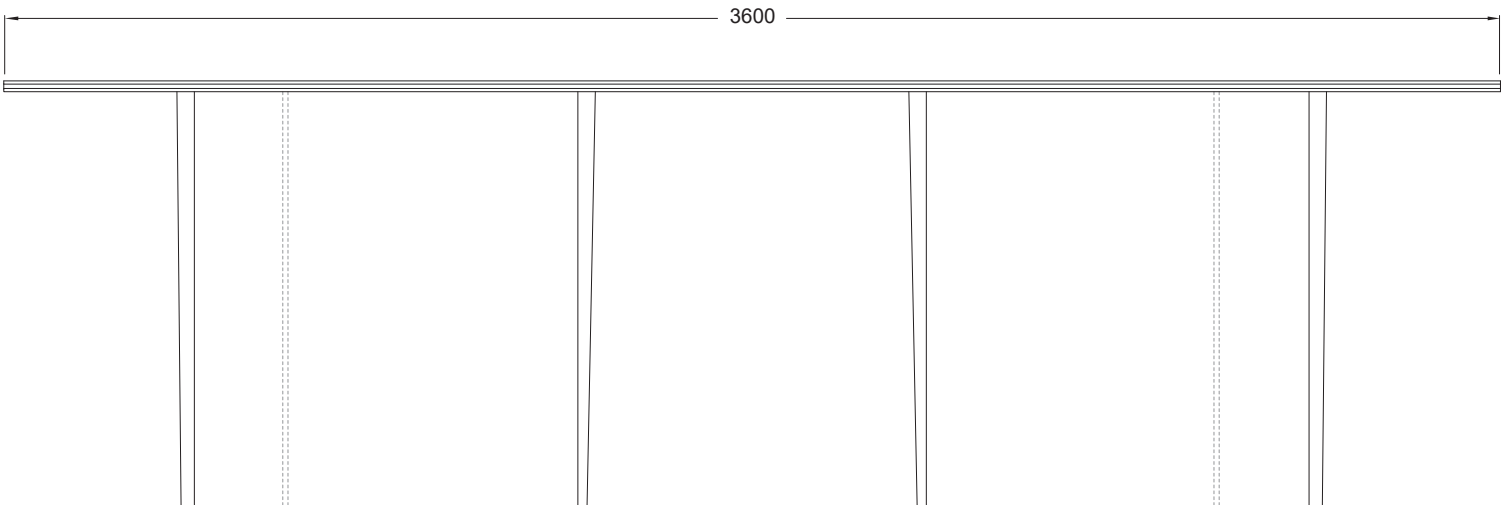
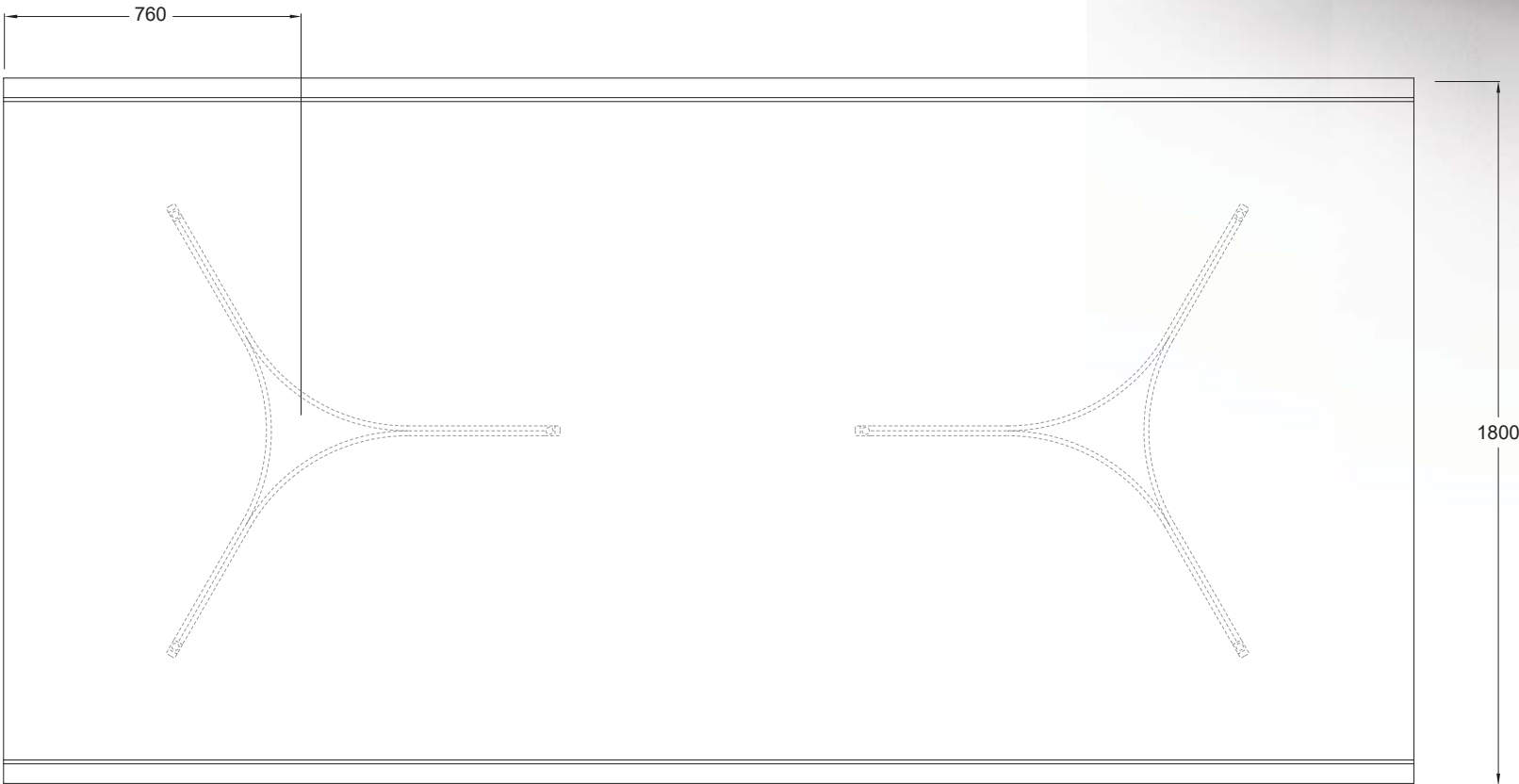
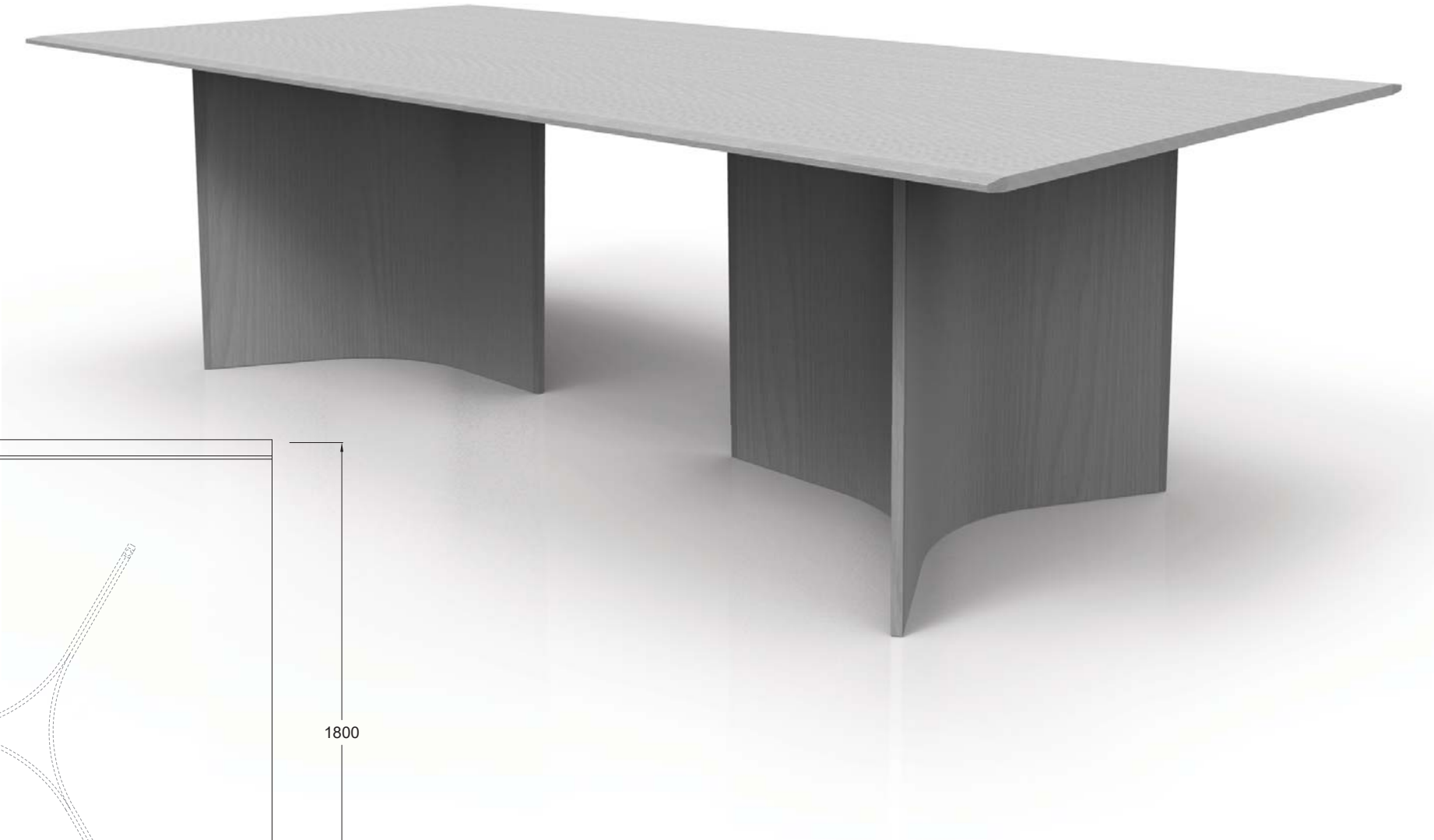

**Didier**<sup>™</sup>

# CREVASSE RANGE - EXTENDED

CV-TB[EXT].420x100

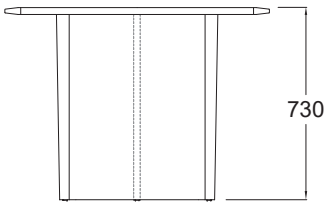
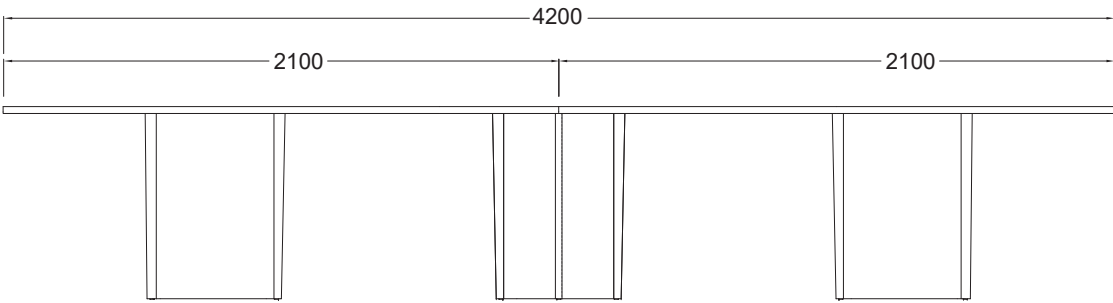
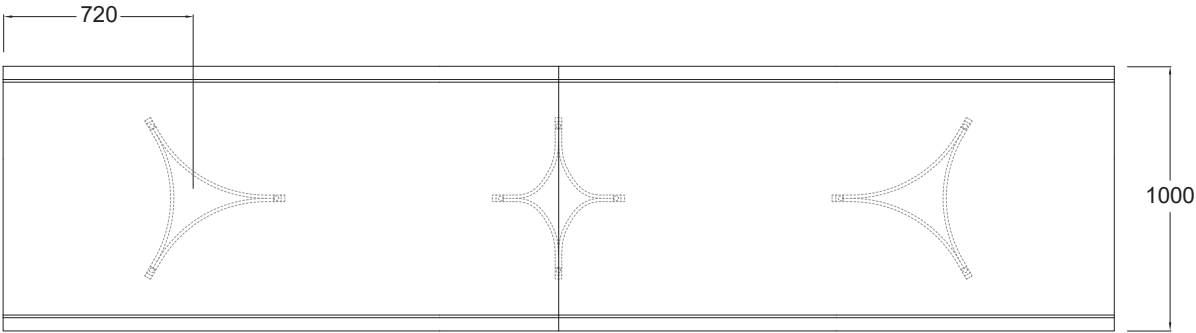
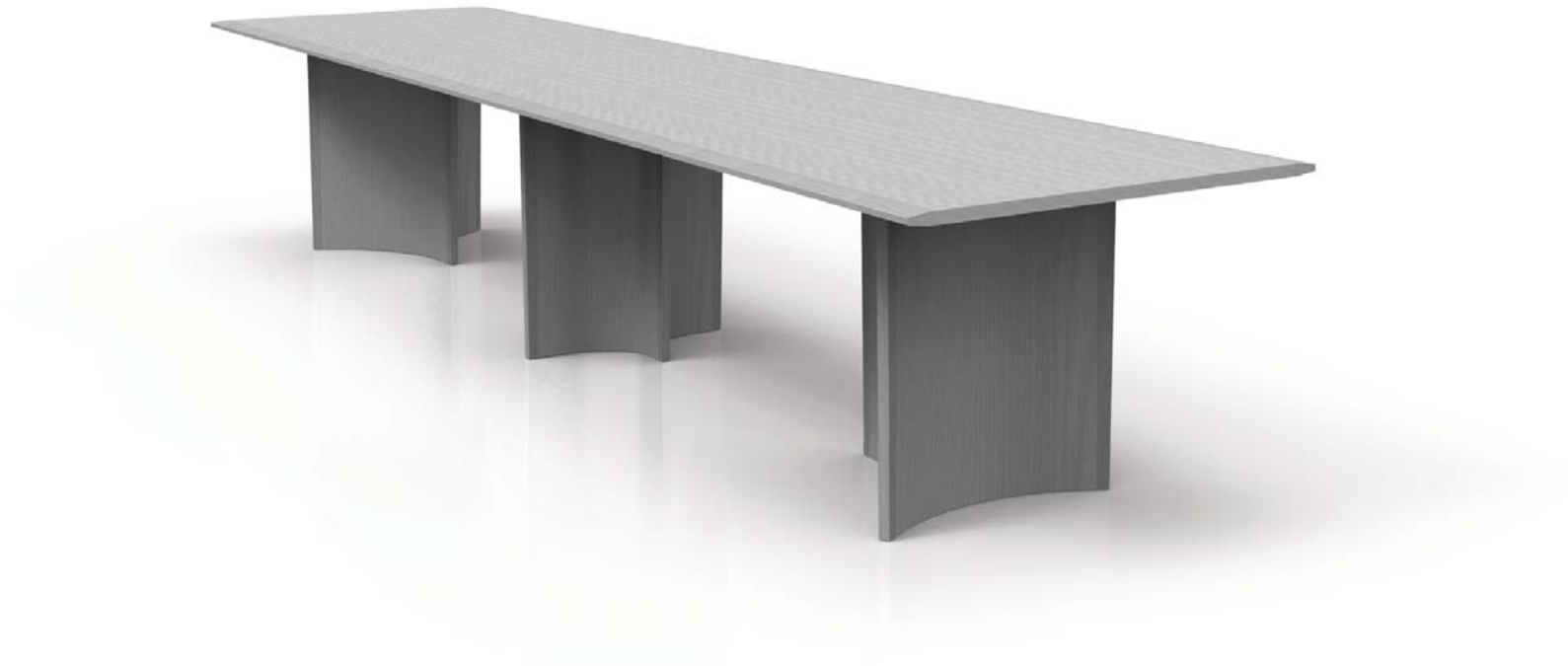

# CREVASSE RANGE - EXTENDED

CV-TB[EXT].480x100

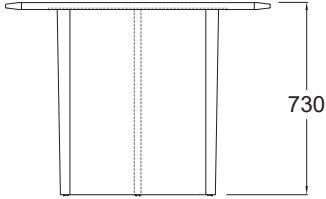
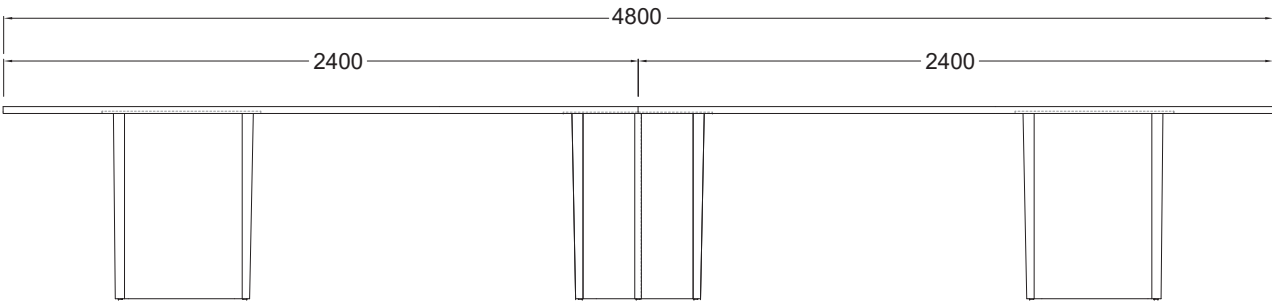
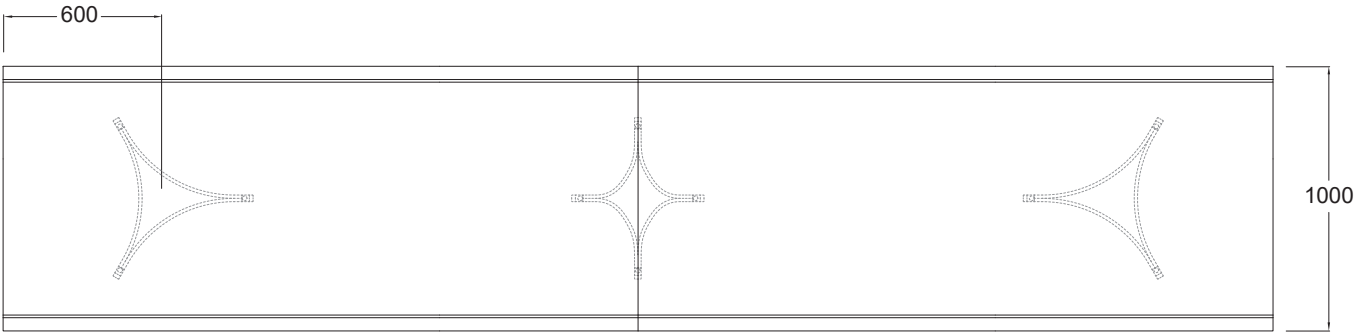
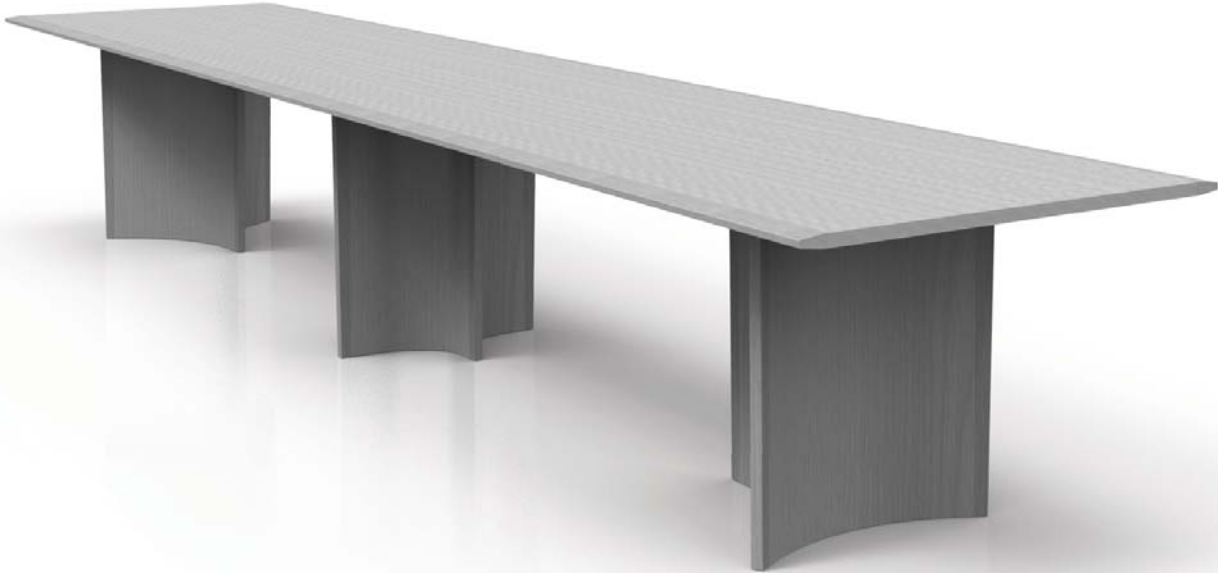

# CREVASSE RANGE - EXTENDED

CV-TB[EXT].540x100

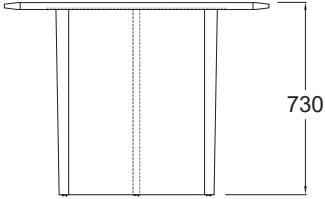
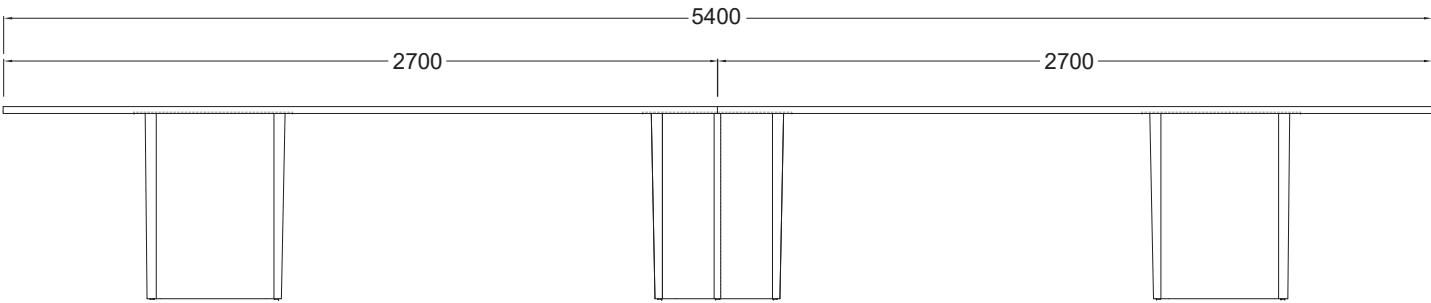
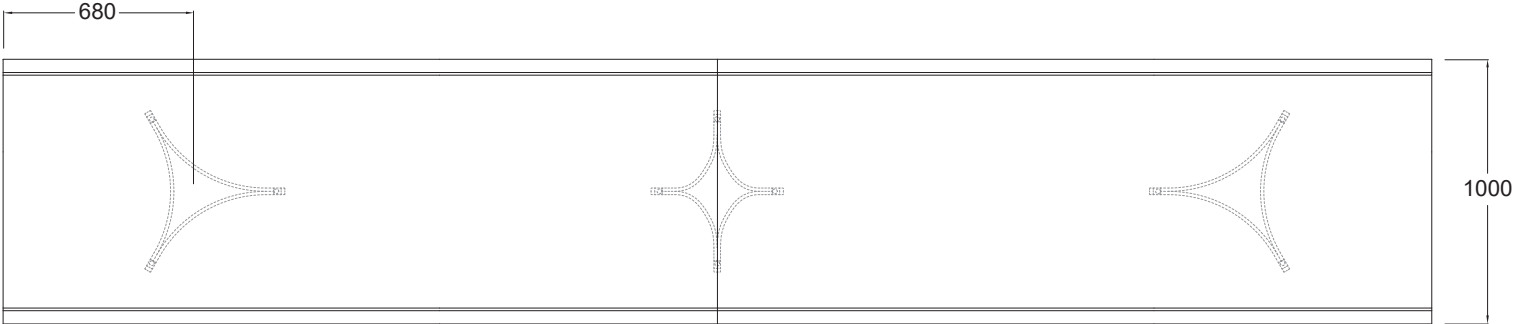
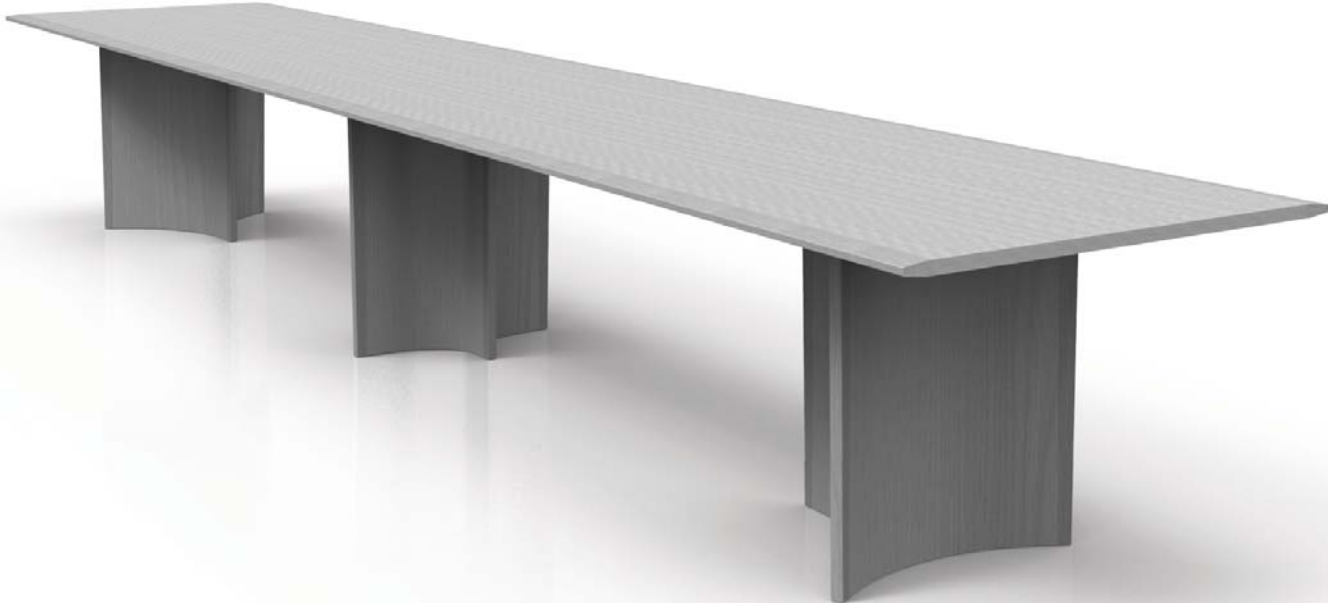

# CREVASSE RANGE - EXTENDED

CV-TB[EXT].600x130

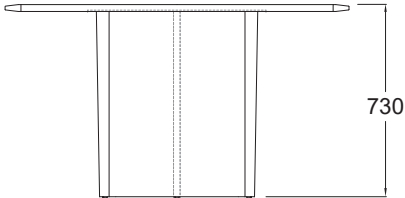
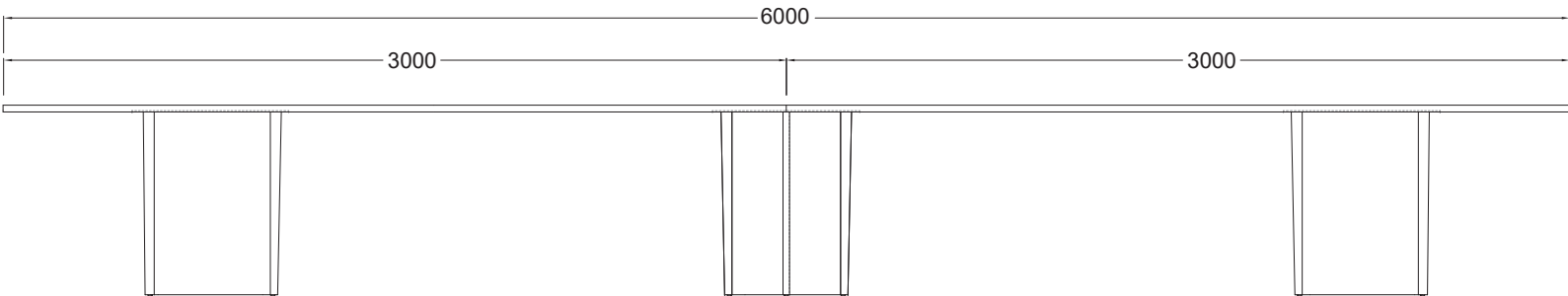
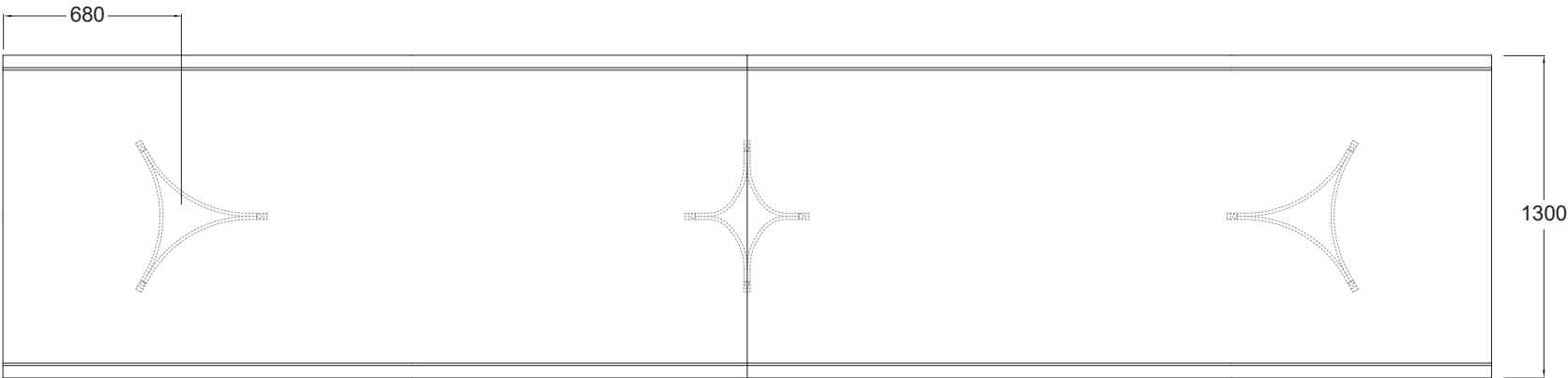
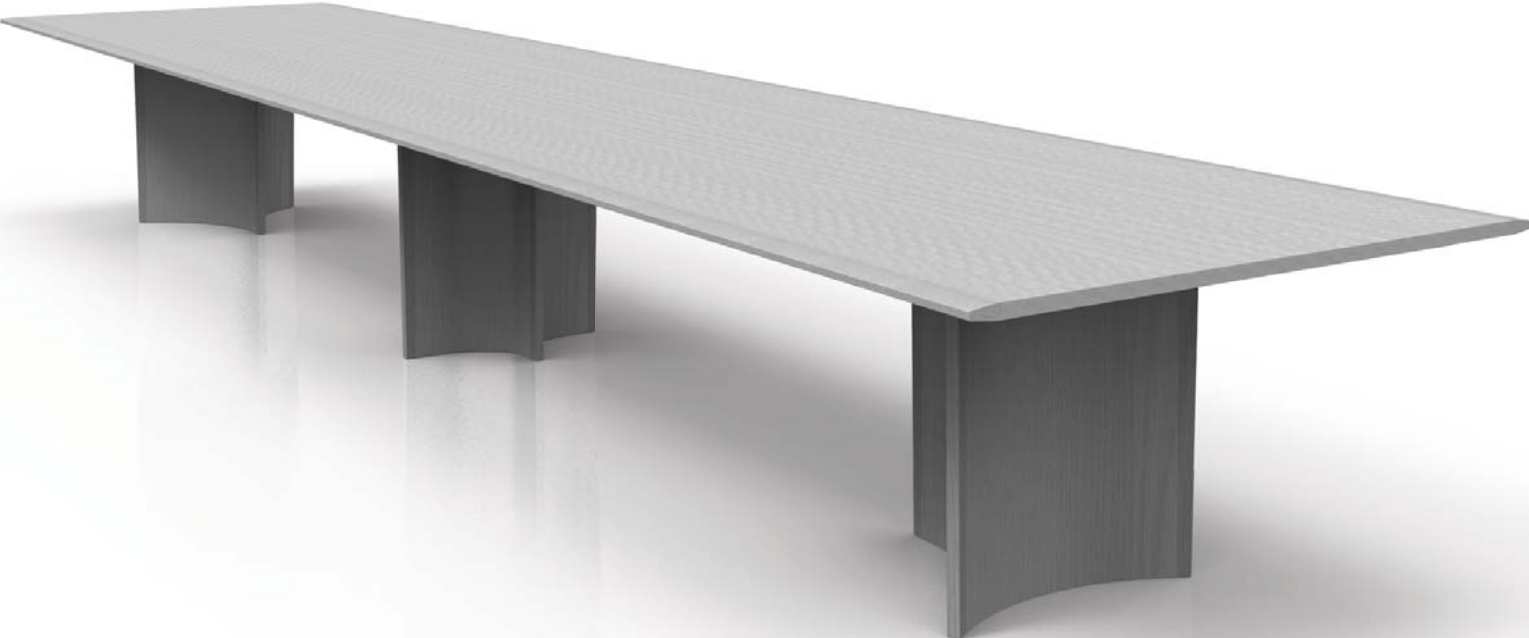



# CREVASSE RANGE - EXTENDED

CV-TB[EXT].660x130

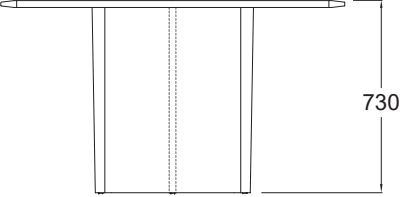
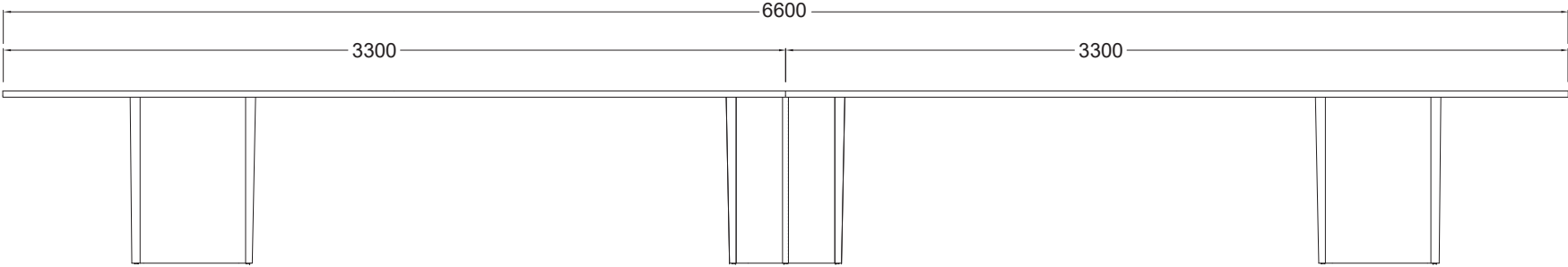
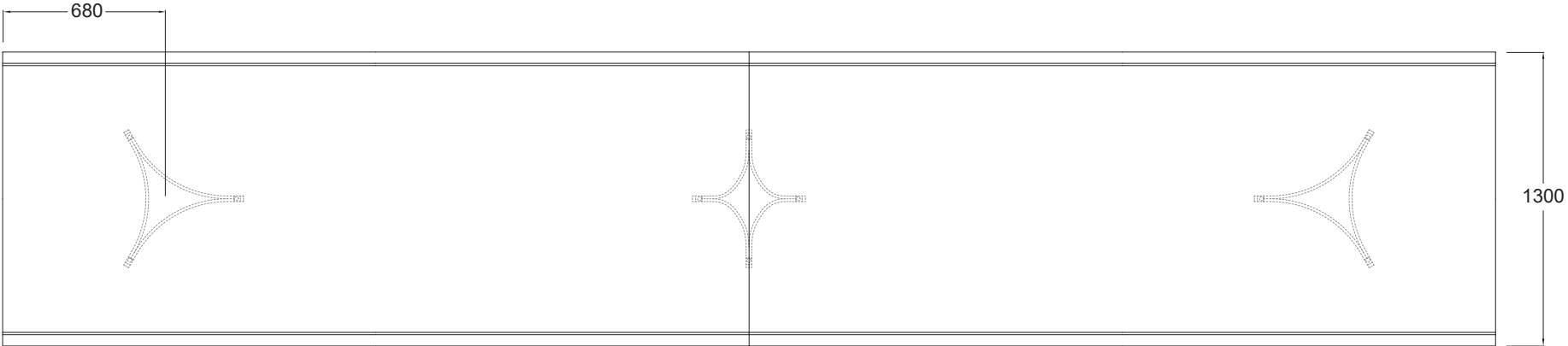
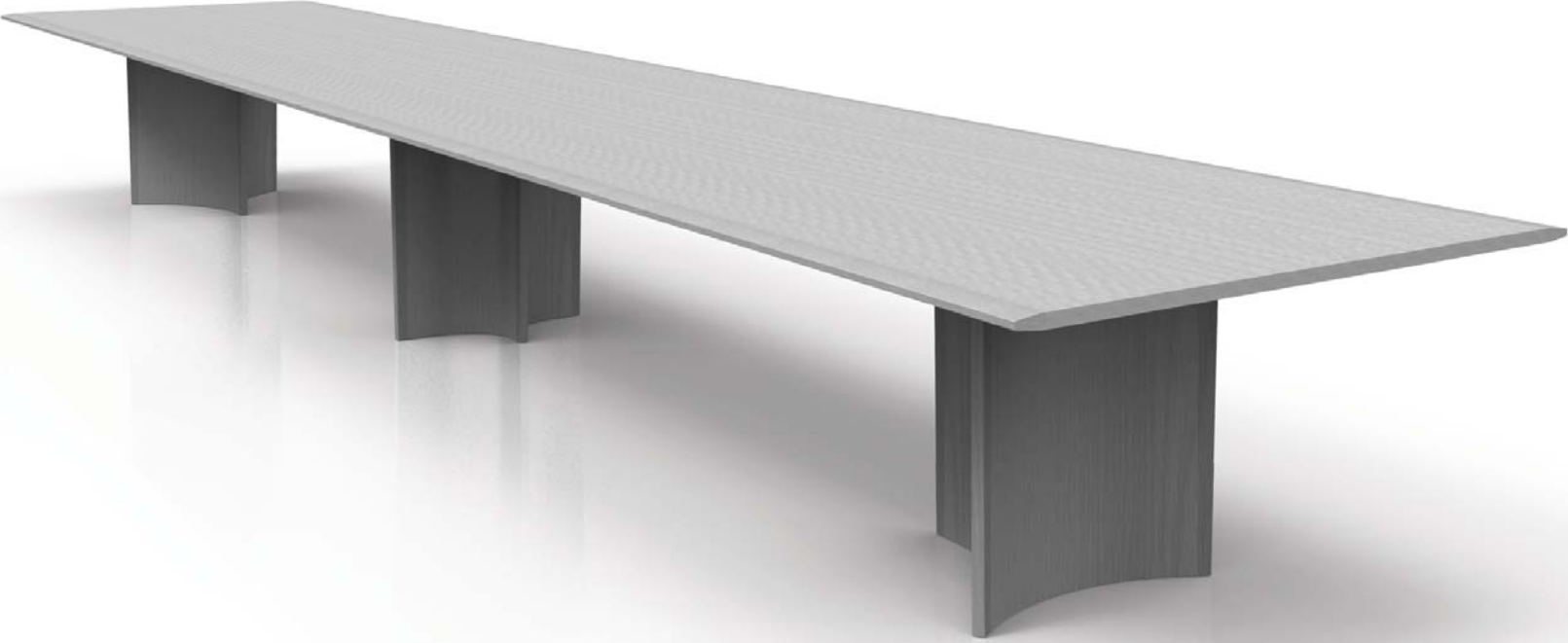

# CREVASSE RANGE - EXTENDED

CV-TB[EXT].720x130

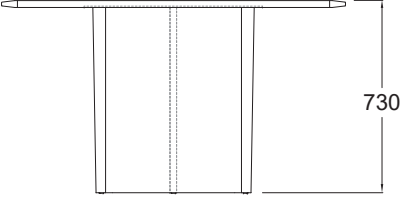
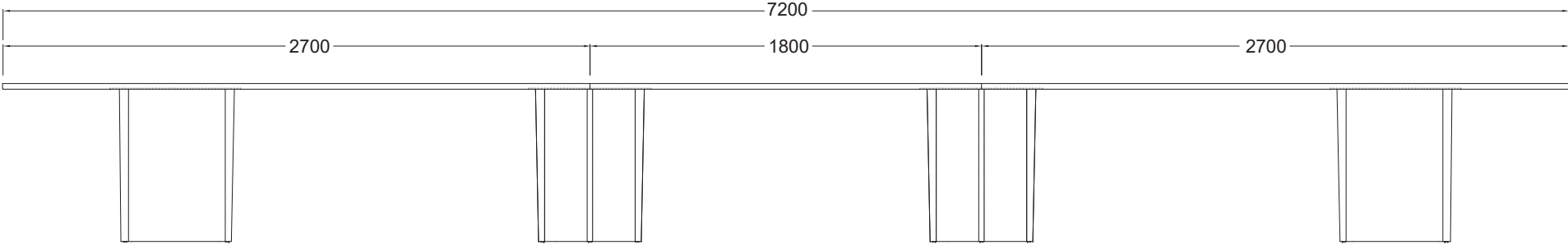
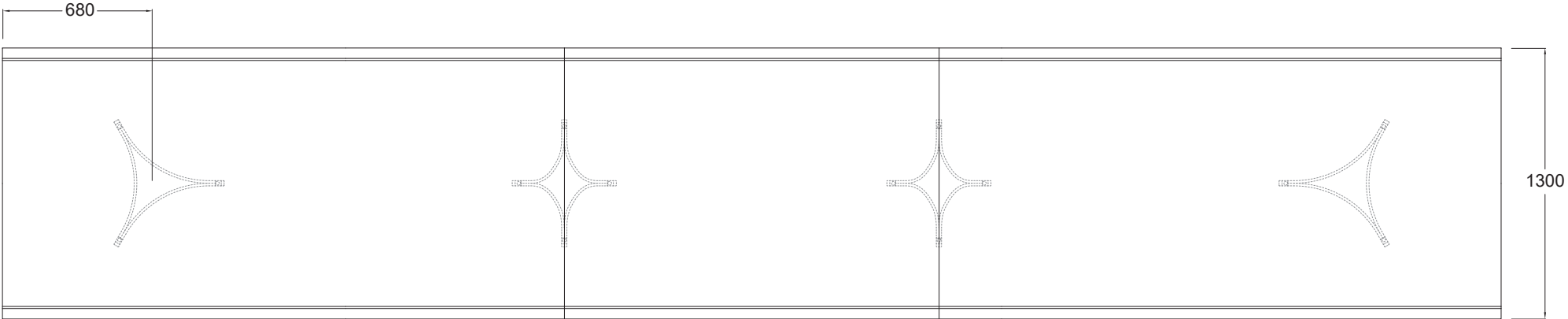
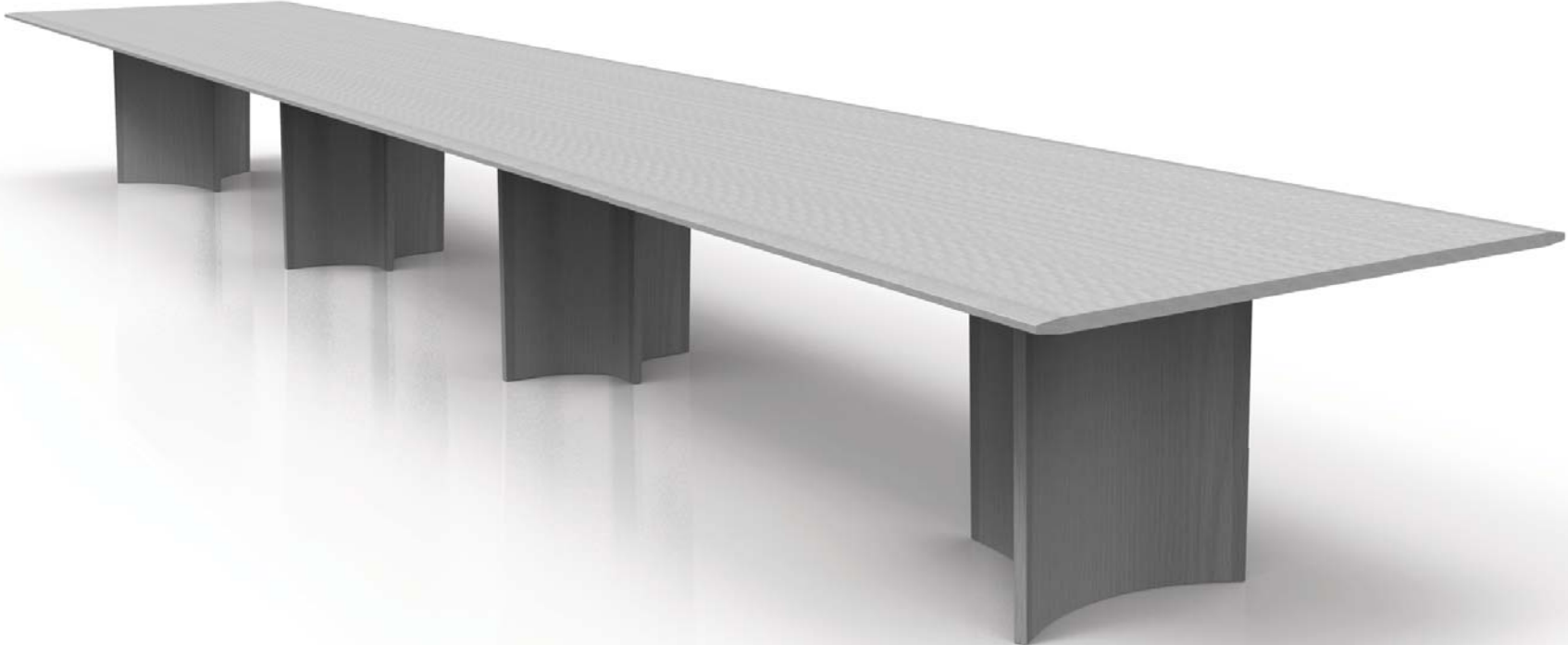

# CREVASSE RANGE - EXTENDED

CV-TB[EXT].810x130

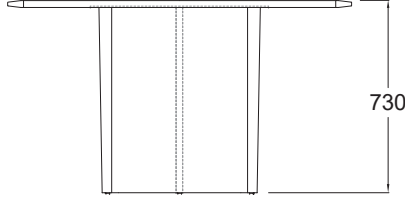
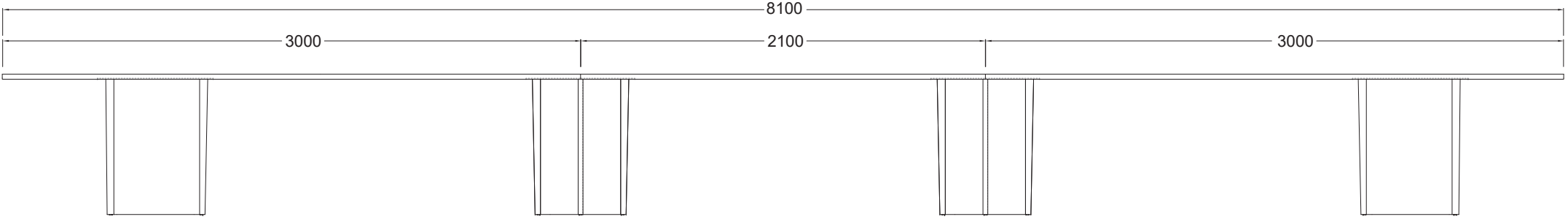
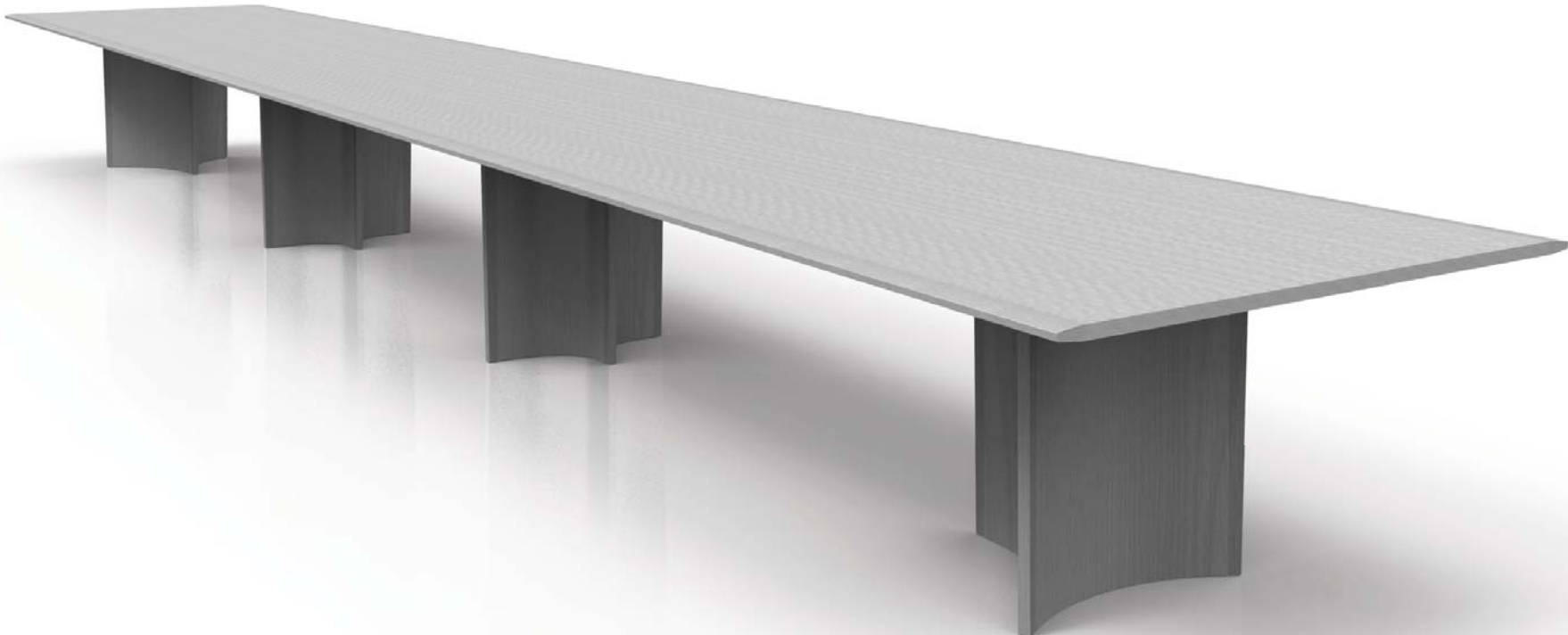

# CREVASSE RANGE - EXTENDED

CV-TB[EXT].900x130

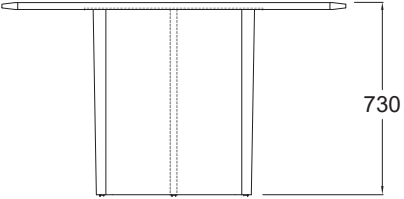
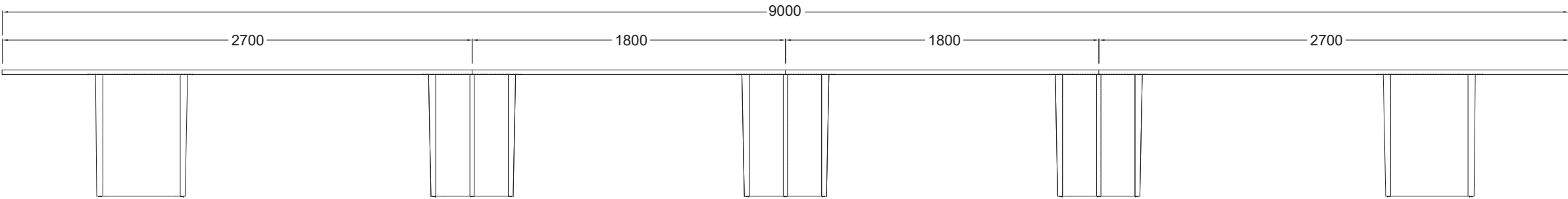
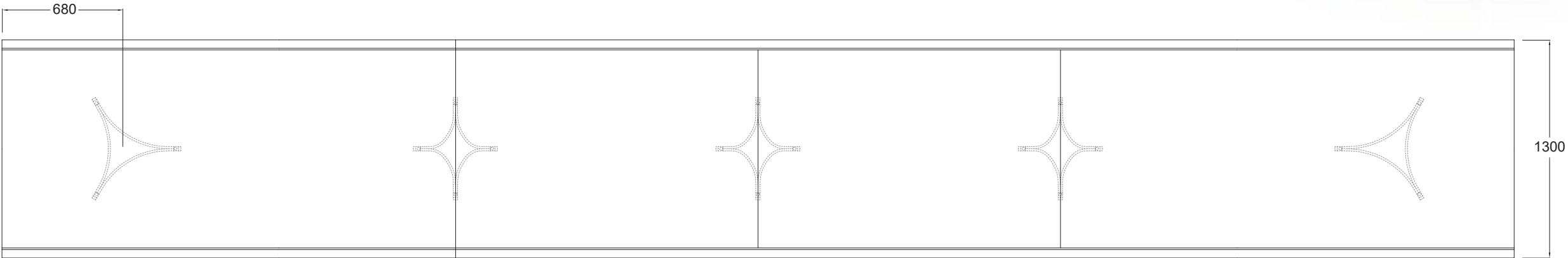

**Didier™**

# CREVASSE RANGE - EXTENDED

CV-TB[EXT].600x150

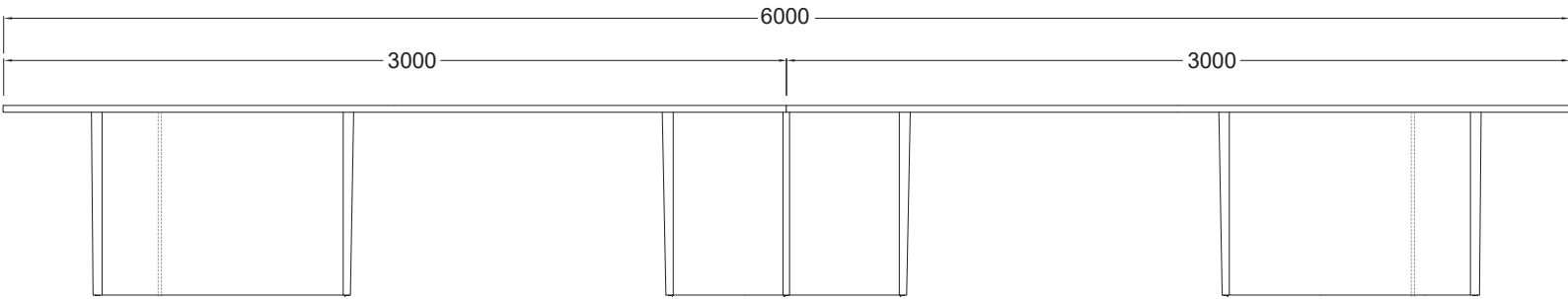
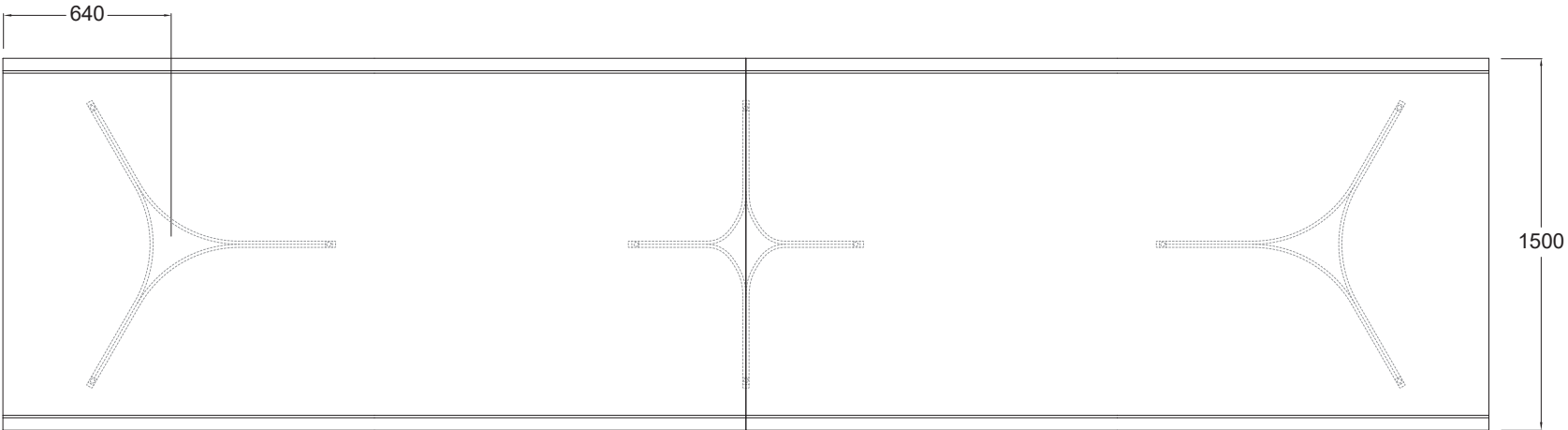
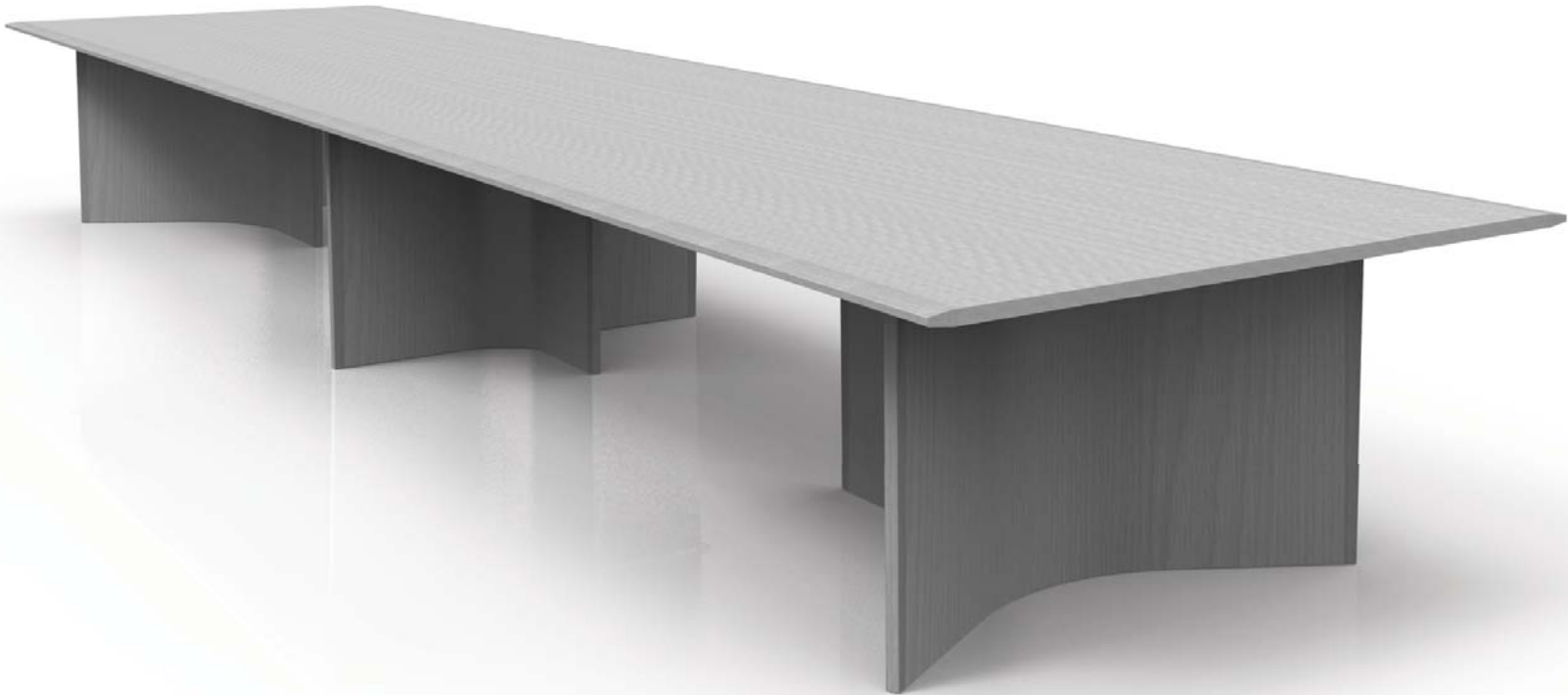

# CREVASSE RANGE - EXTENDED

CV-TB[EXT].840x180

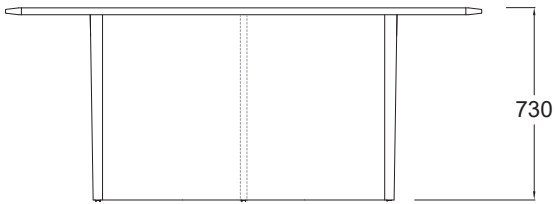
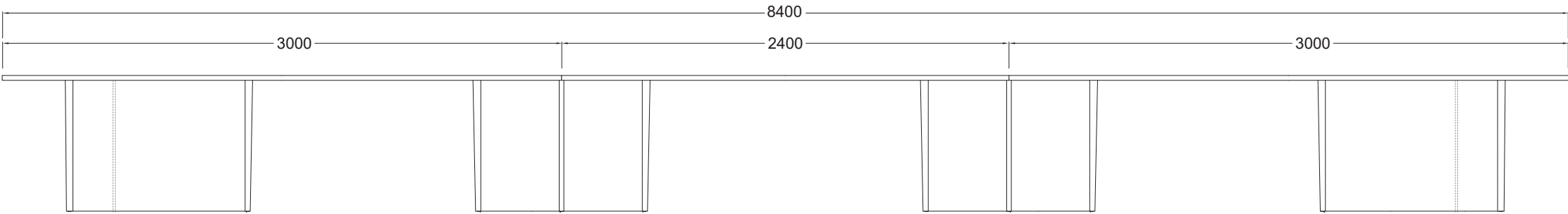
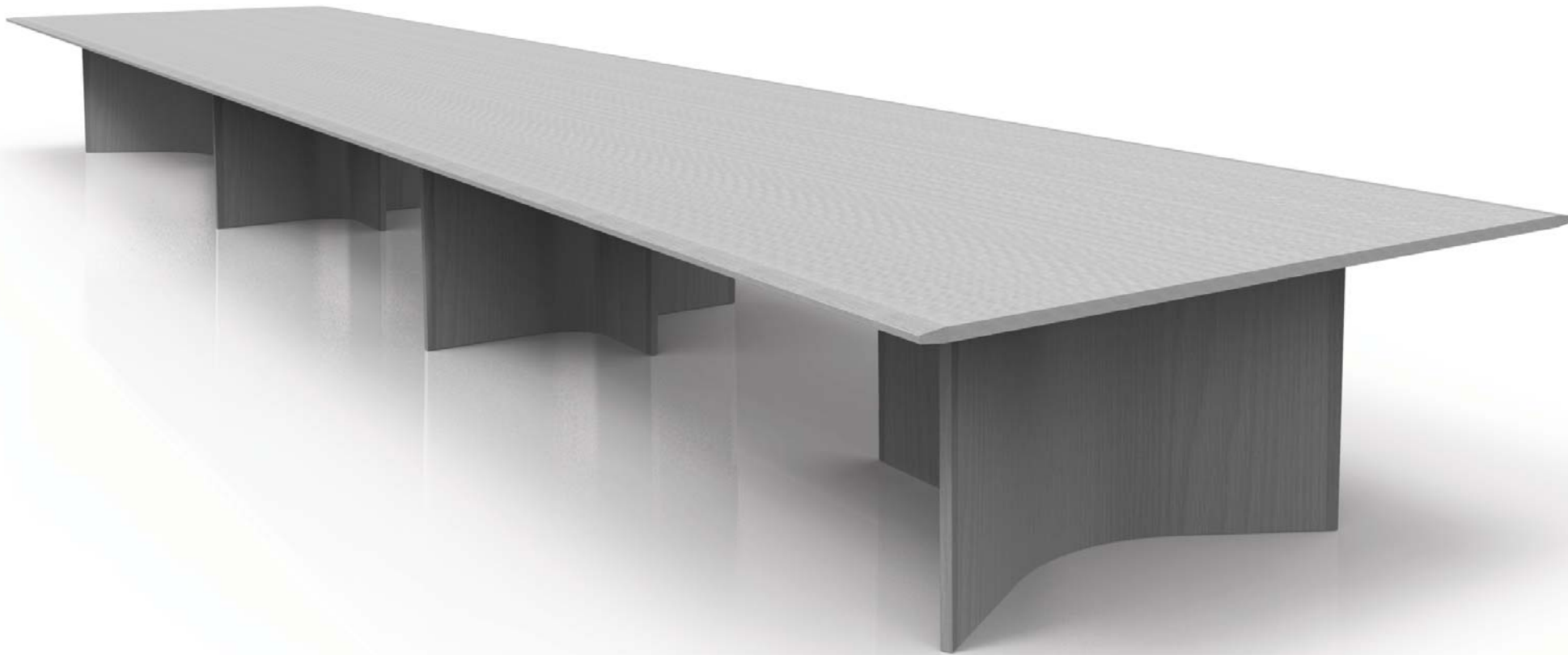

# CREVASSE RANGE - EXTENDED

CV-BTB[90][EXT].480x100

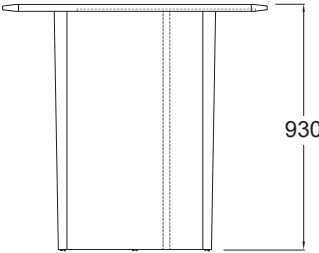
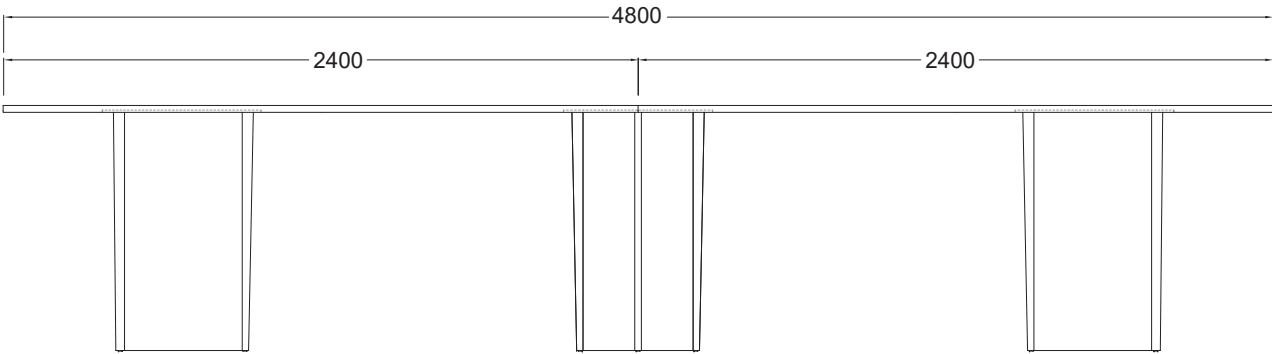
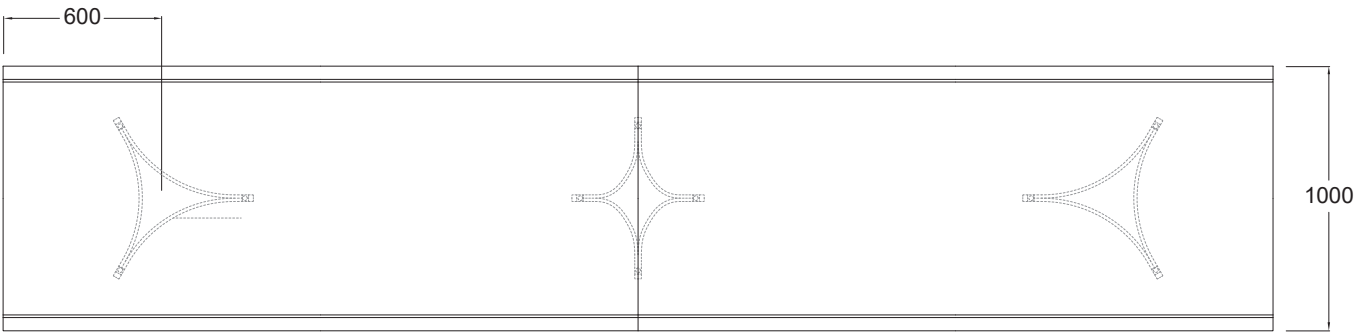

# CREVASSE RANGE - EXTENDED

CV-BTB[90][EXT].720x130

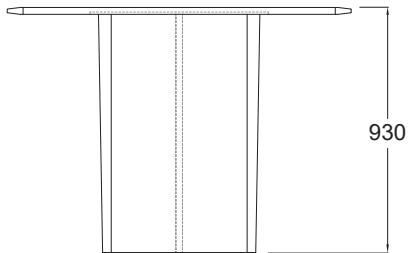
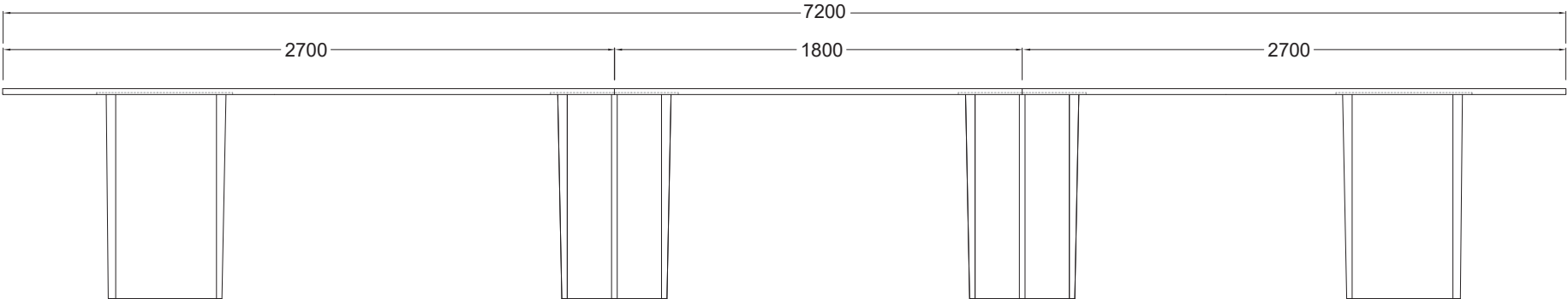



# CREVASSE RANGE - EXTENDED

CV-BTB[90][EXT].900x130

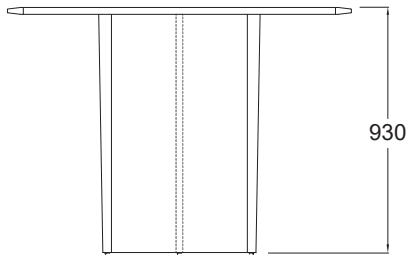
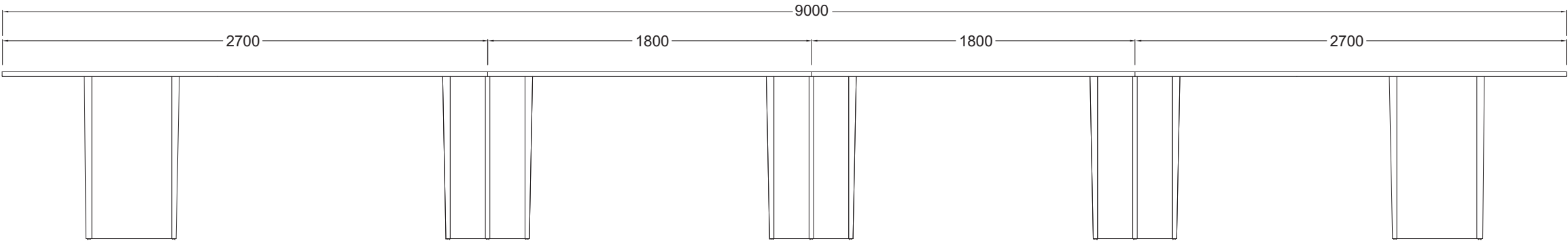
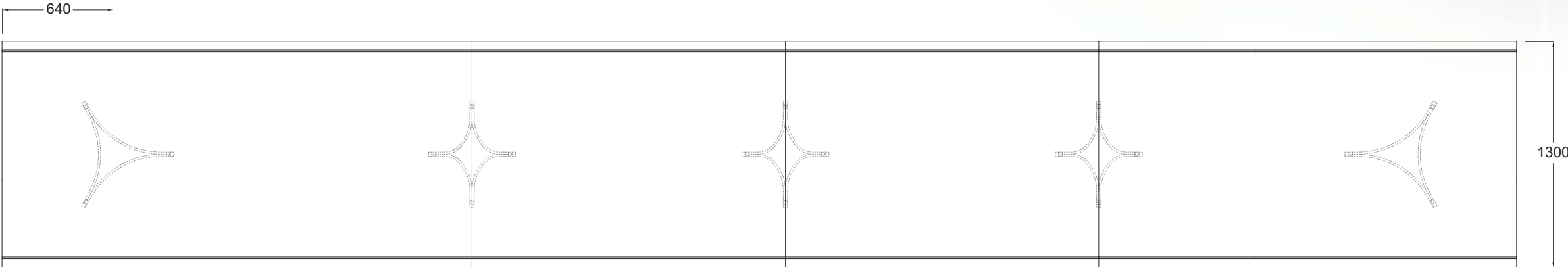

**Didier**<sup>™</sup>

# CREVASSE RANGE - EXTENDED

CV-BTB[90][EXT].600x150

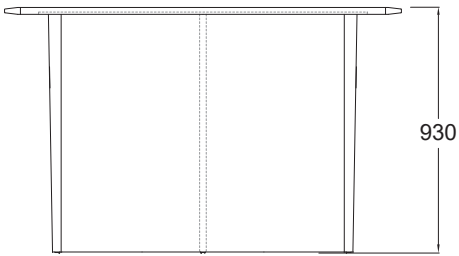
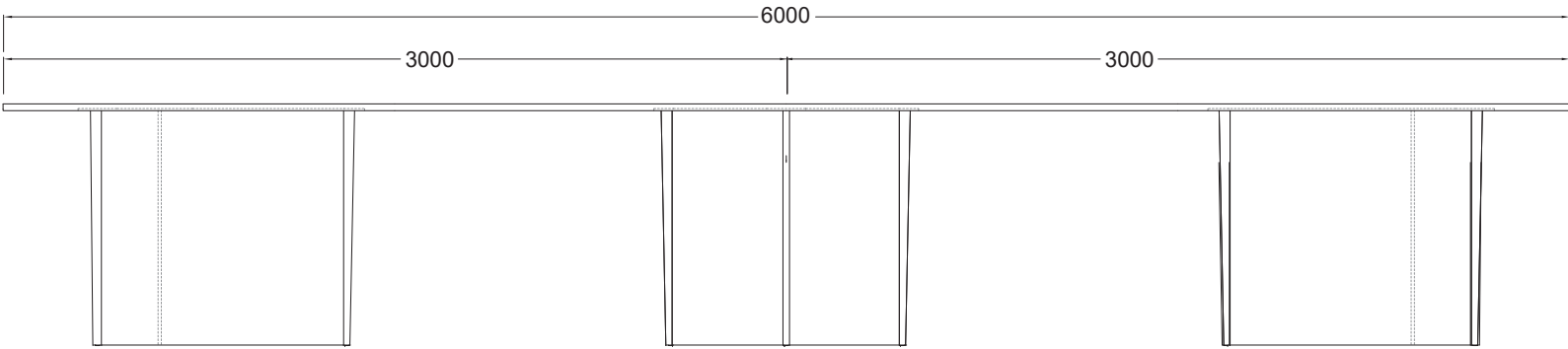
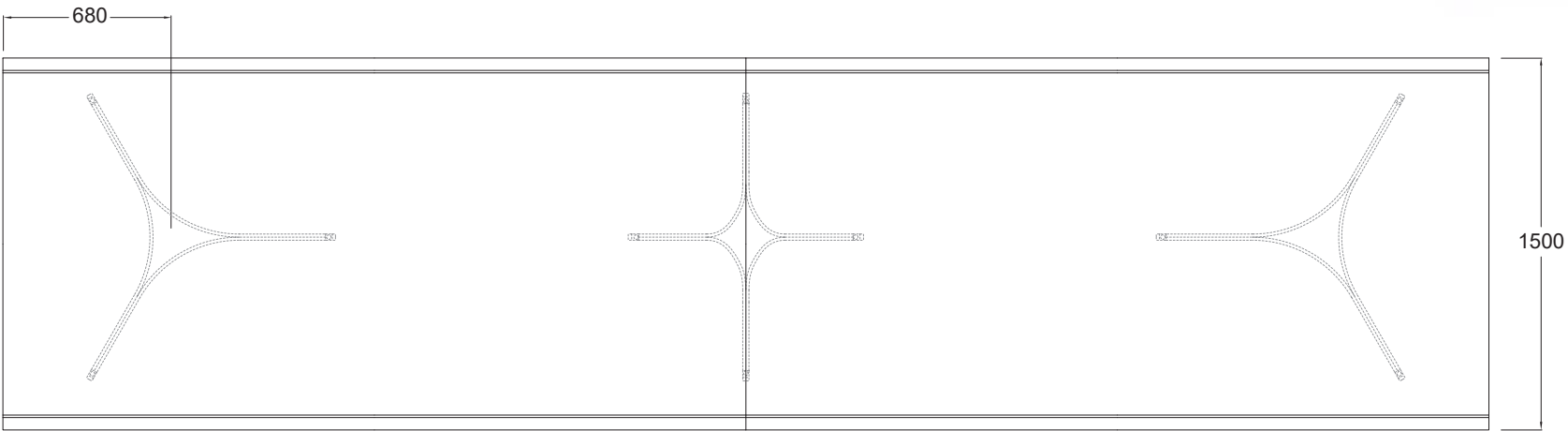
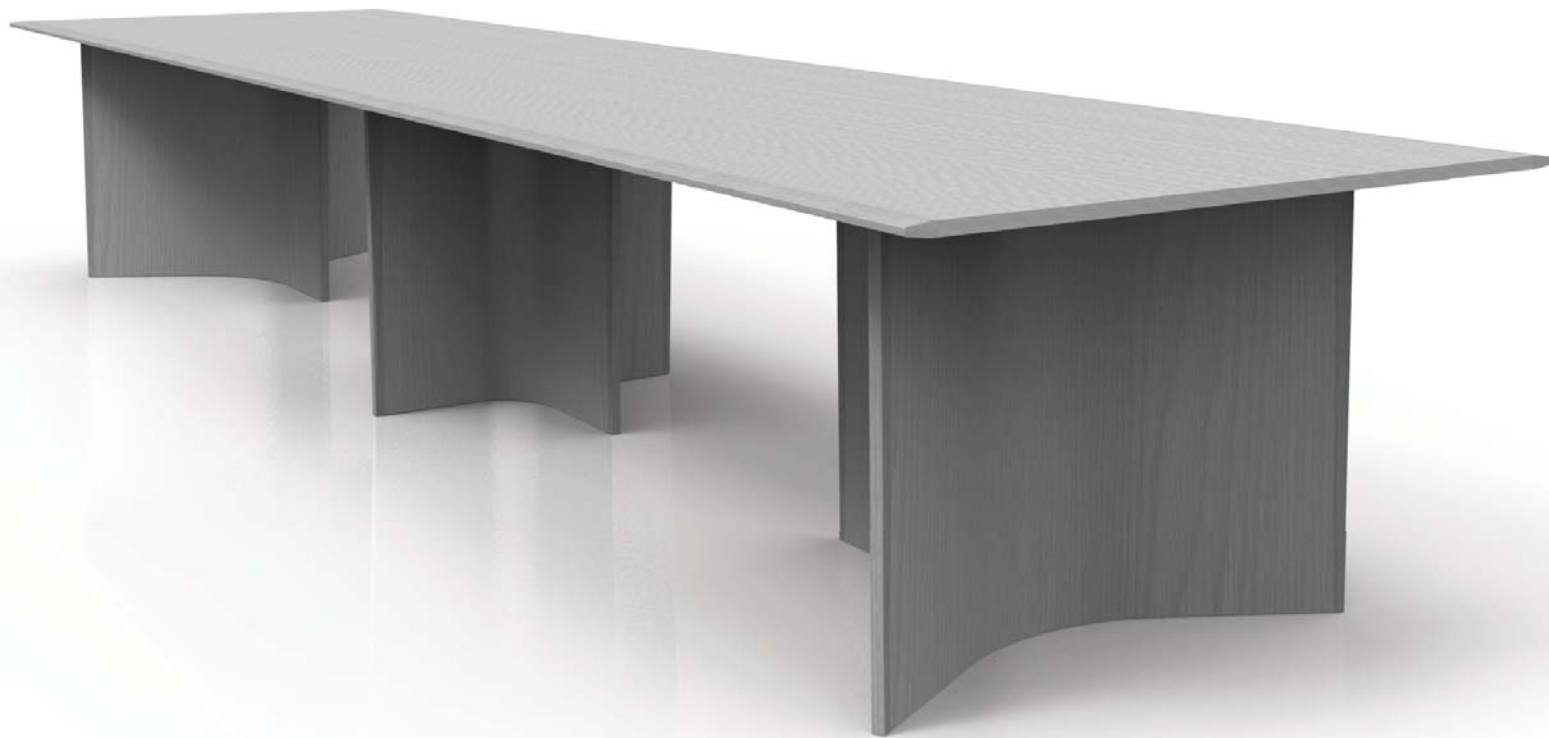

# CREVASSE RANGE - EXTENDED

CV-BTB[103][EXT].540x100

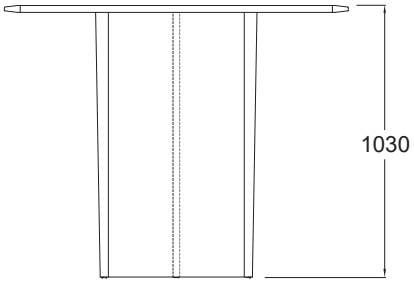
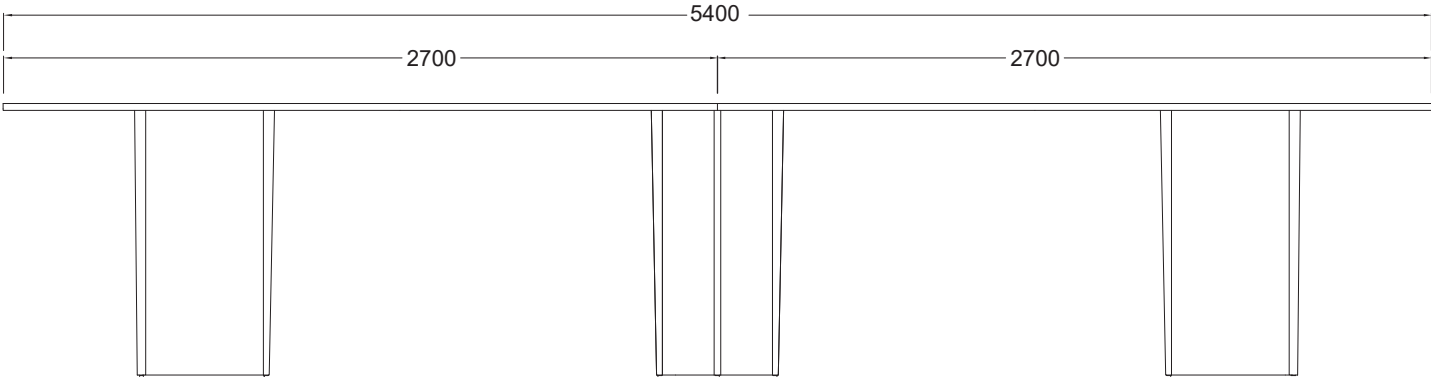
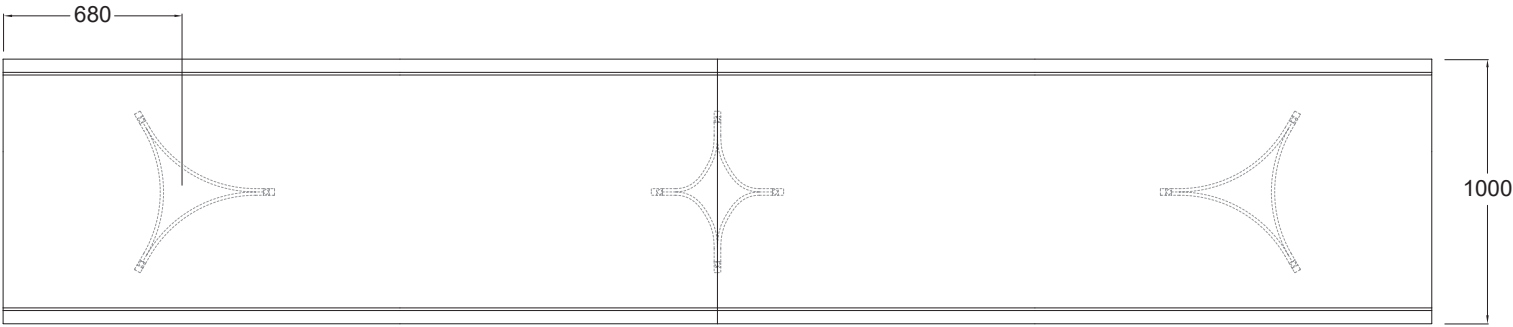

# CREVASSE RANGE - EXTENDED

CV-BTB[103][EXT].810x130

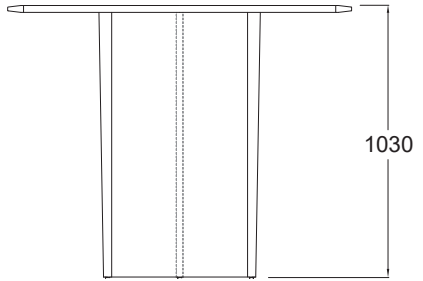
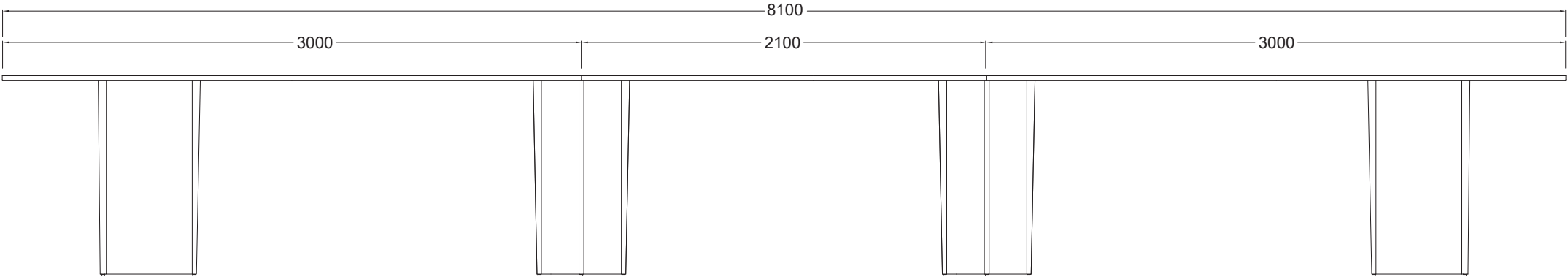
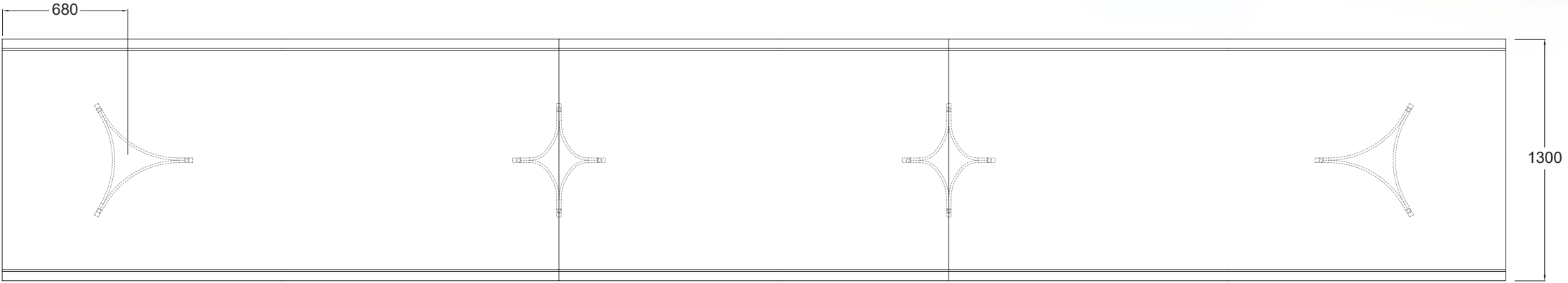

# CREVASSE RANGE - EXTENDED

CV-BTB[103][EXT].840x150

